

Nitrogen 0

CABLE SUSPENDED (CS)

GET A QUOTE >

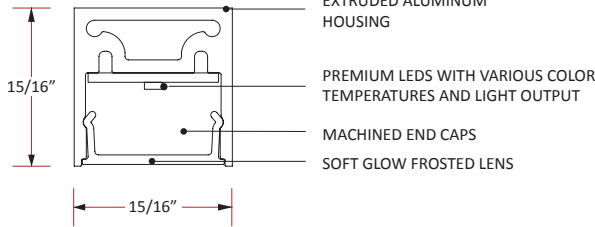
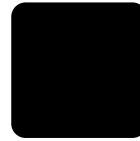

FEATURES:

- Powered Suspension System - No power cord
- High transmission frosted lenses with no diode imaging
- No visible fasteners
- Extruded aluminum housing
- Dimmable/Programmable drivers for controllable light output
- High efficacy LEDs with 5 year warranty
- Under 2 steps MacAdams Ellipse Binning
- 5/16" thick machined end caps
- 360° rotation option- with mechanical locking
- Slightly recessed beveled lens housing

NOTES:

- **REQUIRES REMOTE DRIVER(S)** (see page 6 for more info)

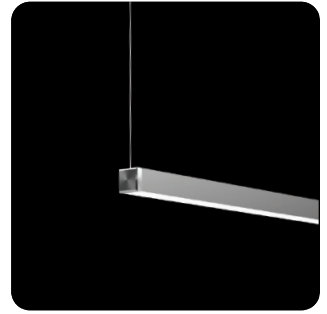

GET A QUOTE >

PRODUCT SPECIFICATION

NOTE: All options *italicized* may increase lead times and/or incur higher costs - please consult factory with questions.

FIXTURE TYPE	MOUNTING/ ORIENTATION	NOMINAL LENGTH*	COLOR TEMP	LED DRIVE POWER	VOLTAGE	DRIVER	HOUSING FINISH
NO Nitrogen 0	CSD Cable Suspended - DIRECT CSI Cable Suspended - INDIRECT CSR Cable Suspended - ROTATIONAL	1' 1'-3/8" 2' 2'-1-3/8" 3' 3'-1-3/8" 4' 4'-1-3/8" CR_ Continuous Run (Specify length in nominal feet)	27K 2700K 30K 3000K 35K 3500K 40K 4000K 50K 5000K	VLO Very Low Output 345 lumens/ft (4w/ft.) LO Low Output 520 lumens/ft. (6w/ft.) SO Standard Output 685 lumens/ft. (8w/ft.) HO High Output 855 lumens/ft. (10w/ft.) VHO Very High Output 995 lumens/ft. (12w/ft.) CPO Custom Power Output Consult factory	UNV Universal (120-277v) 1V 120v 2V 227v 3V 347v*	ND Non-Dimming 0-10v DIMMING 10D 10% DIM 1D 1% DIM LUTRON LTEA Lutron Hi-Lume 1% (2-Wire) LDE1 Lutron EcoSystem 1% "Soft on" (Digital) LDES Lutron EcoSystem 5% 5-Series (Digital) DALI DALI Digital Addressable Lighting Interface	SC Satin Clear Anodize (Standard) SW Satin White (Powder Coat) MB Matte Black (Powder Coat) CF Custom Finish* (Consult Factory)
		<small>*Dimensions are for reference only. Contact factory for more specific information or shop drawings. **Odd lengths may incur slightly higher per foot pricing.</small>			<small>*Not all dimming options are available with 347v.</small>		<small>*RAL and color match are available.</small>

HARDWARE* DETAIL FINISH	DRIVER HOUSING FINISH	CANOPY SIZE OPTIONS*	CANOPY FINISH	POWER CORD COLOR	AIRCRAFT CABLE LENGTH*	OPTIONS/ CUSTOMIZATION*
MF Machined Finish (Standard) CF Custom Finish (Consult Factory)	MA Mill Aluminium* SC Satin Clear SW Satin White SB Satin Black CF Custom Finish (Consult Factory)	5 SERIES CANOPY 55 5" Power feed canopy 5" Non-power feed canopy 52 5" Power feed canopy 2" Non-power feed canopy 50 5" Power feed canopy Canopy only at power feed 4 SERIES CANOPY 44 4" Power feed canopy 4" Non-power feed canopy 41 4" Power feed canopy 1" Non-power feed canopy 40 4" Power feed canopy Canopy only at power feed	SW Satin White (Standard) CPC Custom Powder Coat Canopy Finish* MF Machine Finish (Standard) SW Satin White CF Custom Finish*	PSS Power Suspension System (No Power Cord) CC Custom Cord*	2 2' 4 4' 6 6' 8 8' CL Custom Length** (Specify in feet IE: CL10 for 10')	XX No EMB or Customization EMB7 7 Watt battery back-up** (Approximately 600 lumens) EMB12 12 Watt battery back-up** (Approximately 1,000 lumens) 90 90+ CRI LED BOARDS (2700K - 4000K only) CCP Corners/patterns* CD Custom Driver* CR Customization Requested*
<small>NOTE: MF option is strongly recommended. Other options will result in higher costs and potentially longer lead times. **"Hardware" refers to the end caps and knuckles (knuckles only for the "Rotational" option).</small>	<small>*Most cost effective.</small>	<small>*CONTINUOUS RUNS REQUIRE THE 55" OR THE 44" OPTION. CONSULT FACTORY WITH QUESTIONS. *See options section and installation instructions for more information.</small>	<small>*Consult the factory.</small>		<small>*Cables are field adjustable. ** Consult factory to confirm specific length.</small>	<small>NOTE: Customization may incur higher costs and/or increased lead times. *Consult the factory for all custom options or custom concept requests. **The EMB12 is slightly more expensive than the EMB7 option (BOTH OPTIONS ARE REMOTE ONLY).</small>

SPECIFICATION INFORMATION

GENERAL NOTES:

All fixtures are **UL listed** for **dry** and **damp** locations.
REMOTE DRIVER for all options.
 Please contact the factory with any specification questions.
Italicized grayed out options may incur additional costs and/or extended lead times. Please consult the factory.

FIXTURE ORIENTATION:

Direct (CSD) for downlight applications.
 Indirect (CSI) for uplight applications.
 Rotational (CSR) for adjustable applications: 360 degree rotational capacity with locking mechanism

DRIVER: [REMOTE]

- 1) NON-DIMMING: As described... this fixture will not dim.
- 2) DIMMING: 0-10v: 1%, 10% :: Lutron: 2-wire Forward phase (Hi-Lume 1%), Ecosystem to 1% (Soft On), Ecosystem to 5% (5 Series). "DALI"- Specify driver. See "Dimming Options" on subsequent pages for more information. For other dimming options, consult the factory.
- 3) EMERGENCY: Specify EMB under the Options/Customization category at the end of the cut sheet along with the desired lumen output (600 or 1,000 lumens - the latter is slightly more costly).
- 4) Drivers are programmed according to our standard lumen packages or to custom watt/lumen package requirements.
- 5) Consult factory with any questions or specification requirements.

FINISHES:

The standard finish is a Satin Clear anodized housing with Machine Finished hardware. Machined finish is preferable for machined components (Hardware Detail) - Powder coating these parts may result in additional costs. Consult the factory with any questions about standard or custom finishing options.

CUSTOMIZATION*:

We have numerous custom options available. However, if there is something unique required for a project, from simple options to complete custom requests, we are more than willing to entertain any creative notions you might have. Just ask.



Nitrogen₀

ROTATIONAL ARM MOUNT (RAM)

FEATURES:

- 5/8" diameter rigid tube mounting system
- High transmission frosted lenses with no diode imaging
- No visible fasteners
- Extruded aluminum housing
- Dimmable/Programmable drivers for controllable light output
- High efficacy LEDs with 5 year warranty
- Under 2 steps MacAdams Ellipse Binning
- 5/16" thick machined end caps
- Bi-directional fixture
- 360° rotation option- with mechanical locking

NOTES:

- **REQUIRES REMOTE DRIVER(S)** (see page 6 for more info)

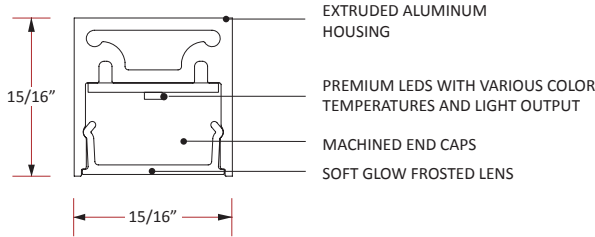
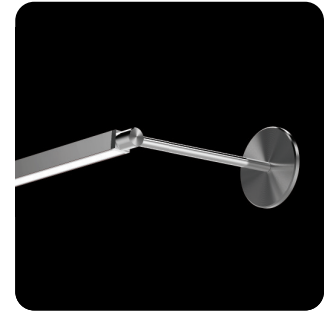

PRODUCT SPECIFICATION

NOTE: All options *italicized* may increase lead times and/or incur higher costs - please consult factory with questions.

FIXTURE TYPE	MOUNTING/ ORIENTATION	NOMINAL LENGTH*	COLOR TEMP	LED DRIVE POWER	VOLTAGE	DRIVER	HOUSING FINISH
NO Nitrogen 0	RAM Rotational Arm Mount	1' 1'-1-3/8" 2' 2'-1-3/8" 3' 3'-1-3/8" 4' 4'-1-3/8" CR Continuous Run (Specify length in nominal feet)	27K 2700K 30K 3000K 35K 3500K 40K 4000K 50K 5000K	VLO Very Low Output 345 lumens/ft (4w/ft.) LO Low Output 520 lumens/ft. (6w/ft.) SO Standard Output 685 lumens/ft. (8w/ft.) HO High Output 855 lumens/ft. (10w/ft.) VHO Very High Output 995 lumens/ft. (12w/ft.) CPO Custom Power Output Consult factory	UNV Universal (120-277v) 1V 120v 2V 227v 3V 347v*	ND Non-Dimming 0-10v DIMMING 10D 10% DIM 1D 1% DIM LUTRON LTEA Lutron Hi-Lume 1% (2-Wire) LDE1 Lutron EcoSystem 1% "Soft on" (Digital) LDES Lutron EcoSystem 5% 5-Series (Digital) DALI DALI Digital Addressable Lighting Interface	SC Satin Clear Anodize (Standard) SW Satin White (Powder Coat) MB Matte Black (Powder Coat) CF Custom Finish* (Consult Factory)
		*Dimensions are for reference only. Contact factory for more specific information or shop drawings. **Odd lengths may incur slightly higher per foot pricing.			*Not all dimming options are available with 347v.		*RAL and color match are available.

HARDWARE* DETAIL FINISH	DRIVER HOUSING FINISH	ARM LENGTH*	MOUNTING/ COVER PLATE	OPTIONS/ CUSTOMIZATION*
MF Machined Finish (Standard) CF Custom Finish (Consult Factory)	MA Mill Aluminium* SC Satin Clear SW Satin White SB Satin Black CF Custom Finish (Consult Factory)	3 3" 6 6" 9 9" 12 12" 18 18"*** CAL Custom Length** (Specify in inches IE: CL10 for 10")	4CPF Flat 4" diameter Cover Plate - For use with a 3-O mud ring 1TR 1" Trim Ring - for use when mounting to finished surface (IE. furniture) NCP No Cover Plate CCP Custom Cover Plate*	XX No EMB or Customization EMB7 7 Watt battery back-up** (Approximately 600 lumens) EMB12 12 Watt battery back-up** (Approximately 1,000 lumens) 90 90+ CRI LED BOARDS (2700K - 4000K only) CCP Corners/patterns* CD Custom Driver* CR Customization Requested*
NOTE: MF option is strongly recommended. Other options will result in higher costs and potentially longer lead times. **Hardware* refers to the end caps and knuckles (knuckles only for the "Rotational" option).	*Most cost effective.	*Arm length is measured from the mounting surface to the center of the fixture. **Limitations apply. Consult the factory.	*Consult the factory.	NOTE: Customization may incur higher costs and/or increased lead times. *Consult the factory for all custom options or custom concept requests. **The EMB12 is more expensive than the EMB7 option (BOTH OPTIONS ARE REMOTE ONLY).

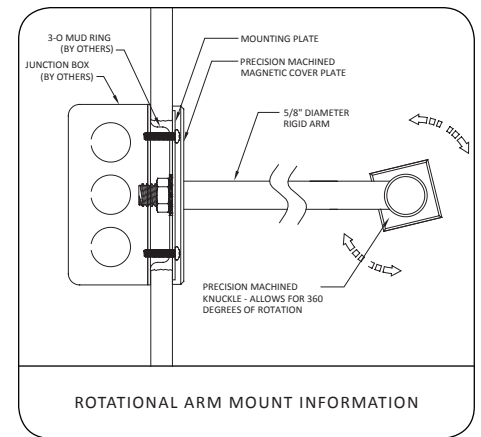

SPECIFICATION INFORMATION

GENERAL NOTES:

All fixtures are **UL listed** for **dry** and **damp** locations.
REMOTE DRIVER for all options.
 Please contact the factory with any specification questions.
Italicized grayed out options may incur additional costs and/or extended lead times. Please consult the factory.

DRIVER: [REMOTE]

- 1) NON-DIMMING: As described... this fixture will not dim.
- 2) DIMMING: 0-10v: 1%, 10% :: Lutron: 2-wire Forward phase (Hi-Lume 1%, Ecosystem to 1% (Soft On), Ecosystem to 5% (5 Series). "DALI"- Specify driver. See "Dimming Options" on subsequent pages for more information. For other dimming options, consult the factory.
- 3) EMERGENCY: Specify EMB under the Options/Customization category at the end of the cut sheet along with the desired lumen output (600 or 1,000 lumens - the latter is slightly more costly).
- 4) Drivers are programmed according to our standard lumen packages or to custom watt/lumen package requirements.
- 5) Consult factory with any questions or specification requirements.

FINISHES:

The standard finish is a Satin Clear anodized housing with Machine Finished hardware. Machined finish is preferable for machined components (Hardware Detail) - Powder coating these parts may result in additional costs. Consult the factory with any questions about standard or custom finishing options.

CUSTOMIZATION:

We have numerous custom options available. However, if there is something unique required for a project, from simple options to complete custom requests, we are more than willing to entertain any creative notions you might have. Just ask.



Nitrogen₀

SURFACE MOUNT (SM)

FEATURES:

- Ceiling or wall mounting system
- High transmission frosted lenses with no diode imaging
- No visible fasteners
- Extruded aluminum housing
- Dimmable/Programmable drivers for controllable light output
- High efficacy LEDs with 5 year warranty
- Under 2 steps MacAdams Ellipse Binning
- 5/16" thick machined end caps
- Slightly recessed beveled lens housing

NOTES:

- **REQUIRES REMOTE DRIVER(S)** (see page 6 for more info)

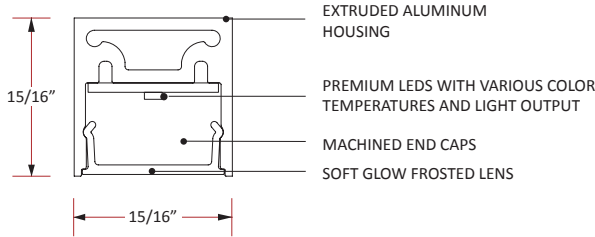
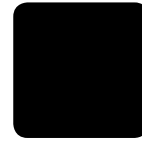

PRODUCT SPECIFICATION

NOTE: All options *italicized* may increase lead times and/or incur higher costs - please consult factory with questions.

FIXTURE TYPE	MOUNTING/ORIENTATION	NOMINAL LENGTH*	COLOR TEMP	LED DRIVE POWER	VOLTAGE	DRIVER	HOUSING FINISH	HARDWARE* DETAIL FINISH
NO Nitrogen 0	SMS Surface Mount - SIDE SMT Surface Mount - TOP	1' 1'-3/8" 2' 2'-1-3/8" 3' 3'-1-3/8" 4' 4'-1-3/8" CR Continuous Run (Specify length in nominal feet)	27K 2700K 30K 3000K 35K 3500K 40K 4000K 50K 5000K	VLO Very Low Output 345 lumens/ft. (4w/ft.) LO Low Output 520 lumens/ft. (6w/ft.) SO Standard Output 685 lumens/ft. (8w/ft.) HO High Output 855 lumens/ft. (10w/ft.) VHO Very High Output 995 lumens/ft. (12w/ft.) CPO Custom Power Output Consult factory	UNV Universal (120-277v) 1V 120v 2V 227v 3V 347v*	ND Non-Dimming 0-10v DIMMING 10D 10% DIM 1D 1% DIM LUTRON LTEA Lutron Hi-Lume 1% (2-Wire) LDE1 Lutron EcoSystem 1% "Soft on" (Digital) LDES Lutron EcoSystem 5% 5-Series (Digital) DALI DALI Digital Addressable Lighting Interface	SC Satin Clear Anodize (Standard) SW Satin White (Powder Coat) MB Matte Black (Powder Coat) CF Custom Finish* (Consult Factory)	MF Machined Finish (Standard) CF Custom Finish (Consult Factory)
		*Dimensions are for reference only. Contact factory for more specific information or shop drawings. **Odd lengths may incur slightly higher per foot pricing.			*Not all dimming options are available with 347v.		*RAL and color match are available.	NOTE: The MF option is strongly recommended. Other options will result in higher costs and potentially longer lead times. **"Hardware" refers to the end caps and knuckles (knuckles only for the "Rotational" option).

DRIVER HOUSING FINISH	STAND OFF DISTANCE	OPTIONS/CUSTOMIZATION*
MA Mill Aluminium* SC Satin Clear SW Satin White SB Satin Black CF Custom Finish (Consult Factory)	0 Flush .5 Half Inch 1 1" 3 3" 6 6" CU Custom (Specify in ft IE: CU4.5 for 4.5')	XX No EMB or Customization EMB7 7 Watt battery back-up** (Approximately 600 lumens) EMB12 12 Watt battery back-up** (Approximately 1,000 lumens) 90 90+ CRI LED BOARDS (2700K - 4000K only) CCP Corners/patterns* CD Custom Driver* CR Customization Requested*
*Most cost effective.		NOTE: Customization may incur higher costs and/or increased lead times. *Consult the factory for all custom options or custom concept requests. **The EMB12 is slightly more expensive than the EMB7 option (BOTH OPTIONS ARE REMOTE ONLY).

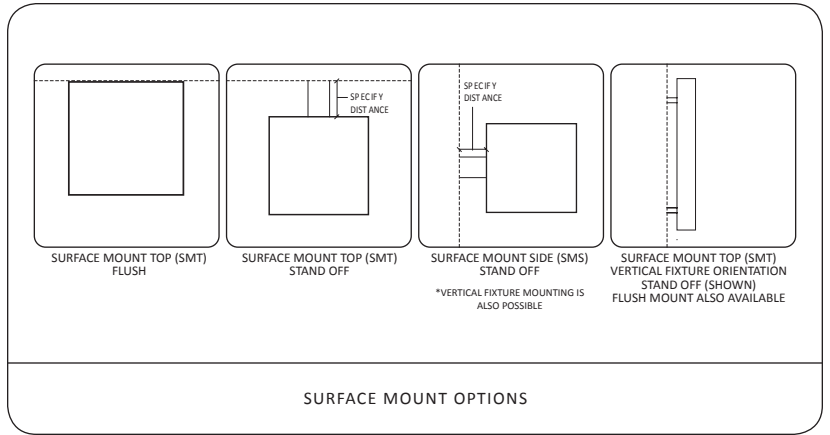

SPECIFICATION INFORMATION

GENERAL NOTES:

All fixtures are **UL listed** for **dry** and **damp** locations.
REMOTE DRIVER for all options.
 Please contact the factory with any specification questions.
Italicized grayed out options may incur additional costs and/or extended lead times. Please consult the factory.

DRIVER: [REMOTE]

- 1) NON-DIMMING: As described... this fixture will not dim.
- 2) DIMMING: 0-10v: 1%, 10% :: Lutron: 2-wire Forward phase (Hi-Lume 1%, Ecosystem to 1% (Soft On), Ecosystem to 5% (5 Series). "DALI" - Specify driver. See "Dimming Options" on subsequent pages for more information. For other dimming options, consult the factory.
- 3) EMERGENCY: Specify EMB under the Options/Customization category at the end of the cut sheet along with the desired lumen output (600 or 1,000 lumens - the latter is slightly more costly).
- 4) Drivers are programmed according to our standard lumen packages or to custom watt/lumen package requirements.
- 5) Consult factory with any questions or specification requirements.

FINISHES:

The standard finish is a Satin Clear anodized housing with Machine Finished hardware. Machined finish is preferable for machined components (Hardware Detail) - Powder coating these parts may result in additional costs. Consult the factory with any questions about standard or custom finishing options.

CUSTOMIZATION:

We have numerous custom options available. However, if there is something unique required for a project, from simple options to complete custom requests, we are more than willing to entertain any creative notions you might have. Just ask.



Nitrogen₀

ASYMMETRICAL MOUNTING SYSTEM (ASM)

FEATURES :

- Unique, single point, asymmetric mounting system
- High transmission frosted lenses with no diode imaging
- No visible fasteners
- Extruded aluminum housing
- Dimmable/Programmable drivers for controllable light output
- High efficacy LEDs with 5 year warranty
- Under 2 steps MacAdams Ellipse Binning
- 5/16" thick machined end caps
- 360° rotation option - with cable or tube suspension

NOTES :

- **REQUIRES REMOTE DRIVER(S)** (see page 6 for more info)

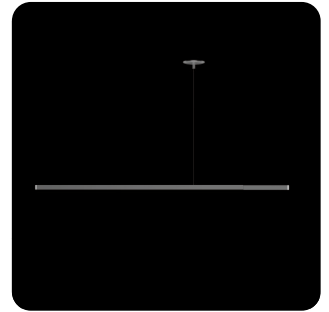
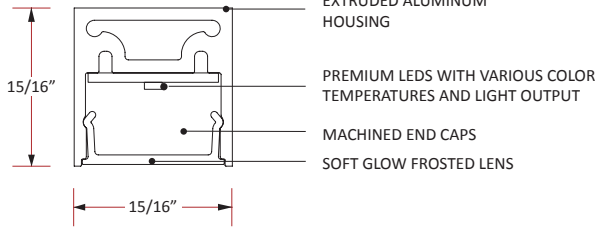
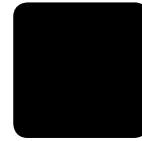

PRODUCT SPECIFICATION

NOTE: All options *italicized* may increase lead times and/or incur higher costs - please consult factory with questions.

FIXTURE TYPE	MOUNTING	FIXTURE ORIENTATION	NOMINAL LENGTH*	COLOR TEMP	LED DRIVE POWER	VOLTAGE	DRIVER	HOUSING FINISH
NO Nitrogen 0	ASM-C Asymmetric Suspension Mount - ASM-T Asymmetric Suspension Mount - TUBE	D Direct I Indirect R Rotational	2' 24" Lit - 12" Non-Lit 3' 36" Lit - 18" Non-Lit 4' 48" Lit - 24" Non-Lit	27K 2700K 30K 3000K 35K 3500K 40K 4000K 50K 5000K	VLO Very Low Output 345 lumens/ft. (4w/ft.) LO Low Output 520 lumens/ft. (6w/ft.) SO Standard Output 685 lumens/ft. (8w/ft.) HO High Output 855 lumens/ft. (10w/ft.) VHO Very High Output 995 lumens/ft. (12w/ft.) CPO Custom Power Output Consult factory	UNV Universal (120-277v) 1V 120v 2V 227v 3V 347v*	ND Non-Dimming 0-10v DIMMING 10D 10% DIM 1D 1% DIM LUTRON LTEA Lutron Hi-Lume 1% (2-Wire) LDE1 Lutron EcoSystem 1% "Soft on" (Digital) LDES Lutron EcoSystem 5% 5-Series (Digital) DALI DALI Digital Addressable Lighting Interface	SC Satin Clear Anodize (Standard) SW Satin White (Powder Coat) MB Matte Black (Powder Coat) CF Custom Finish* (Consult Factory)
			*Actual non-lit lengths are nominal.			*Not all dimming options are available with 347v.		*RAL and color match are available.

HARDWARE* DETAIL FINISH	DRIVER HOUSING FINISH	CANOPY SIZE OPTIONS*	CANOPY FINISH	POWER CORD COLOR	AIRCRAFT CABLE LENGTH*	OPTIONS/ CUSTOMIZATION*
MF Machined Finish (Standard) CF Custom Finish (Consult Factory)	MA Mill Aluminium* SC Satin Clear SW Satin White SB Satin Black CF Custom Finish (Consult Factory)	5 5" Power feed canopy 4 4" Power feed canopy	SW Satin White (Standard) CPC Custom Powder Coat Canopy Finish* MF Machine Finish (Standard) SW Satin White CF Custom Finish*	PSS Power Suspension System (No Power Cord) NA Not Applicable (Use with ASM-T Specification) CC Custom Cord*	1' 12" 2' 24" 3' 36" 4' 49" CU Custom Length** (Specify in feet IE: CU4 for 4')	XX No EMB or Customization EMB7 7 Watt battery back-up** (Approximately 600 lumens) EMB12 12 Watt battery back-up** (Approximately 1,000 lumens) 90 90+ CRI LED BOARDS (2700K - 4000K only) CCP Corners/patterns* CD Custom Driver* CR Customization Requested*
NOTE: MF option is strongly recommended. Other options will result in higher costs and potentially longer lead times. **"Hardware" refers to the end caps and knuckles (knuckles only for the "Rotational" option).	*Most cost effective.	*See options section and installation instructions for more information.	*Just about any finish is possible. For the 4" machined canopies, MF is strongly recommended. Contact the factory with questions or requests.	*Consult the factory.	*Cables are field adjustable. ** Consult factory to confirm specific length.	NOTE: Customization may incur higher costs and/or increased lead times. *Consult the factory for all custom options or custom concept requests. **The EMB12 is slightly more expensive than the EMB7 option (BOTH OPTIONS ARE REMOTE ONLY).

SPECIFICATION INFORMATION

GENERAL NOTES:

All fixtures are **UL listed** for **dry** and **damp** locations.
REMOTE DRIVER for all options.
Please contact the factory with any specification questions.
Italicized grayed out options may incur additional costs and/or extended lead times. Please consult the factory.

FIXTURE ORIENTATION:

Direct (CSD) for downlight applications.
Indirect (CSI) for uplight applications.
Rotational (CSR) for adjustable applications: 360 degree rotational capacity with locking mechanism

DRIVER: [REMOTE]

- 1) NON-DIMMING: As described... this fixture will not dim.
- 2) DIMMING: 0-10v: 1%, 10% :: Lutron: 2-wire Forward phase (Hi-Lume 1%), Ecosystem to 1% (Soft On), Ecosystem to 5% (5 Series). "DALI" - Specify driver. See "Dimming Options" on subsequent pages for more information. For other dimming options, consult the factory.
- 3) EMERGENCY: Specify EMB under the Options/Customization category at the end of the cut sheet along with the desired lumen output (600 or 1,000 lumens - the latter is slightly more costly).
- 4) Drivers are programmed according to our standard lumen packages or to custom watt/lumen package requirements.
- 5) Consult factory with any questions or specification requirements.

FINISHES:

The standard finish is a Satin Clear anodized housing with Machine Finished hardware. Machined finish is preferable for machined components (Hardware Detail) - Powder coating these parts may result in additional costs. Consult the factory with any questions about standard or custom finishing options.

CUSTOMIZATION:

We have numerous custom options available. However, if there is something unique required for a project, from simple options to complete custom requests, we are more than willing to entertain any creative notions you might have. Just ask.



PRODUCT SPECIFICATION

- Fixture delivered light potential: 87 Lumens/Watt*
- Uniform light distribution
- 90+ CRI LED diode options
- Exceptional binning- less than 2 step MacAdams Ellipse
- Minimum 70% initial lumen output at 70,000 hours
- Standard 0-10v dimming to %10
- Lutron, Eldoled, Dali, and other dimming options
- 5 year system warranty

*Actual fixture efficacy will be dependent on specification. Higher lumens per watt are achieved with lower drive powers. Please contact the factory with questions or for more information.

LUMEN OUTPUT*

DRIVER OUTPUT	LUMEN OUTPUT (PER FOOT)	
	WATTAGE	LUMENS
VERY LOW (VLO)	4	345
LOW (LO)	6	520
STANDARD (SO)	8	685
HIGH (HO)	10	855
VERY HIGH (VHO)	12	995

DRIVER OUTPUT	PER 4' FIXTURE (TOTAL DELIVERED LUMENS)	
	WATTAGE	LUMENS
VERY LOW (VLO)	16	1,380
LOW (LO)	24	2,080
STANDARD (SO)	32	2,740
HIGH (HO)	40	3,420
VERY HIGH (VHO)	48	3,980

VERY LOW: Considerably underdrives the LEDs to maximize fixture efficacy potential and limit wattage use.

LOW: Underdrives the LEDs for reasonable light output while maintaining low wattage use.

STANDARD: Drives the LEDs for the best combination of lumen output and fixture efficacy.

HIGH: Drive the LEDs at higher capacity for higher lumen output with good efficacy.

VERY HIGH: Drives the LEDs at the highest capacity for the highest lumen output with the best efficacy.

*Lumen output will vary depending on ambient temperature. Cooler ambient and LED color temperatures result in higher luminaire performance. Calculations are based on 4000K LEDs.

LUMINOUS INTENSITY DISTRIBUTION

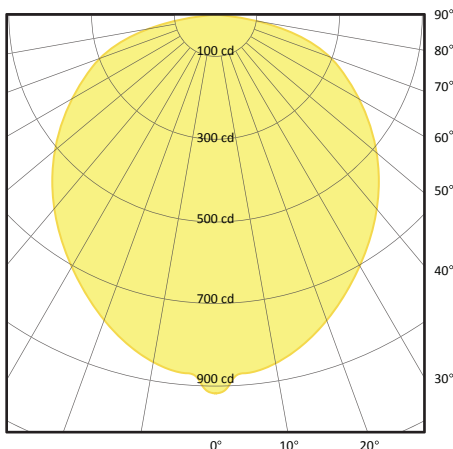

FIXTURE PROPERTIES (AS TESTED)

- 4' nominal length fixture
- Standard Output (SO)
- Total system energy consumption: 32 Watt
- 87 Lumens/Watt
- 4000K 80 CRI LED

ZONAL LUMEN SUMMARY

ZONE	LUMEN	%LAMP	%FIXTURE
0 - 30	670	15.5%	24.5%
0 - 40	1,092	25.3%	40%
0 - 60	1,971	45.6%	72.2%
0 - 90	2,731	63.2%	100%

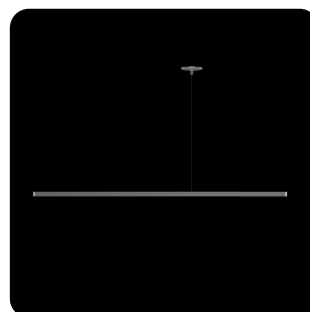
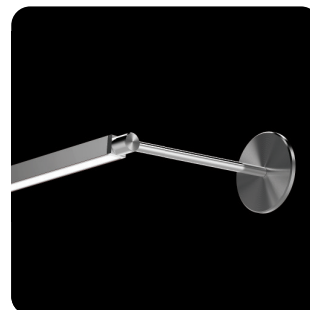
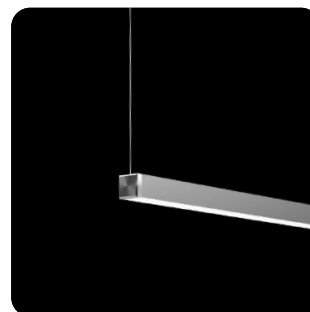

REMOTE DRIVER HOUSING INFORMATION



REMOTE DRIVER HOUSING SIZES

The driver housing length is typically dictated by the options selected. Standard driver housing lengths are as shown. Non standard driver requests may increase or decrease the driver housing length. Specifications are subject to change without notice. Consult factory with questions, requests, or size limitations and we will do our best to accommodate your needs.

STANDARD DRIVER HOUSING

22"

DOUBLE DRIVER HOUSING

40"

SINGLE DRIVER + EMERGENCY BATTERY BACKUP HOUSING

50"

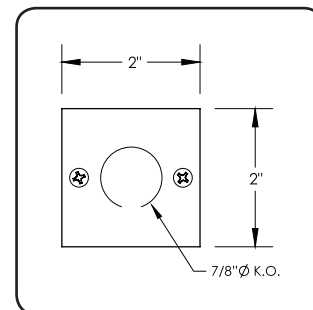

DRIVER HOUSING PROFILE

INSTRUCTIONS

See below for lid removal and installation instructions.

To remove the driver housing lid, use a broad slot screwdriver in the channel as shown here and twist the screwdriver ninety degrees. This may need to be done at both ends of the housing or multiple locations depending on the driver housing length.

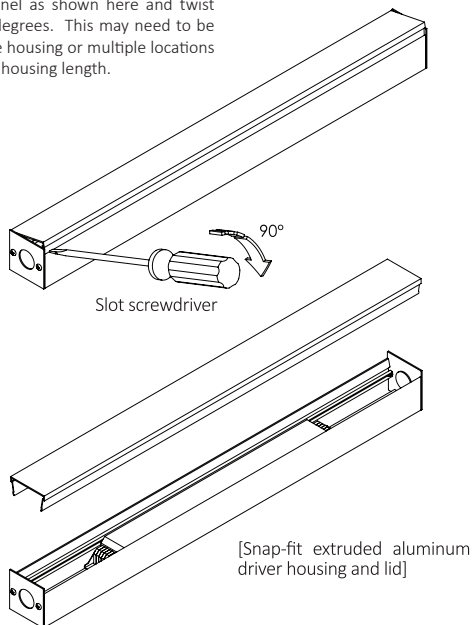

1) Drill mounting holes in the driver housing as needed to secure to a suitable surface. (If needed, a power feed hole can be drilled into the bottom of the housing for certain mounting/power feed applications).

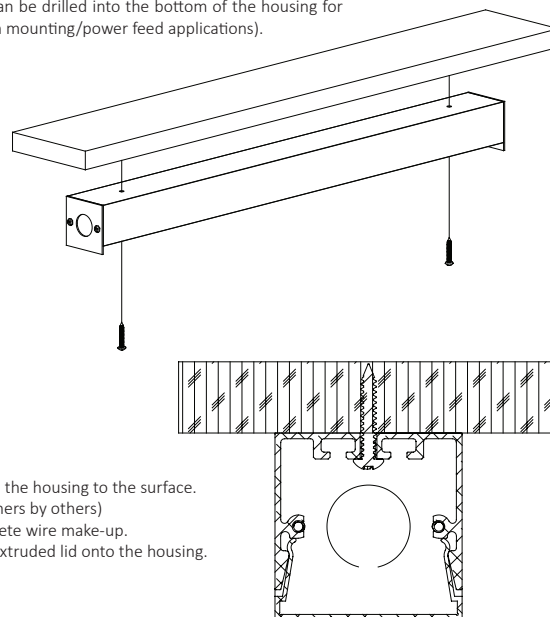

2) Secure the housing to the surface. (Fasteners by others)
3) Complete wire make-up.
4) Snap extruded lid onto the housing.

FINISHES

Mill Aluminum (MA) is the standard finish. Satin White and Satin Black powder coat and Satin Clear anodized finishes can be done for a small charge. Custom finishes are possible. Contact the factory for specific finish options, specific requests, RAL colors, or any other questions.



Mill Aluminum (MA)
[Standard Finish]



Satin White (SW)
[Upgrade Finish]



Satin Black (SB)
[Upgrade Finish]



Satin Clear (SC)
[Upgrade Finish]



Custom Finish (CF)
[Upgrade Finish]



NOTES

Other options are possible. Please contact the factory with custom requests.



Lumium Lighting, LLC | 3590 Cadillac Ave, Suite A, Costa Mesa, CA 92626 | Phone: 760.757.2530 | Fax: 760.283.2333 | www.lumiumlighting.com

While we always strive to ensure all website content and product information is current, Lumium Lighting reserves the right to change specifications without notice. © Lumium Lighting, LLC - All rights reserved.

0618



Lumium
lighting at its element

OPTIONS GUIDE

MOUNTING

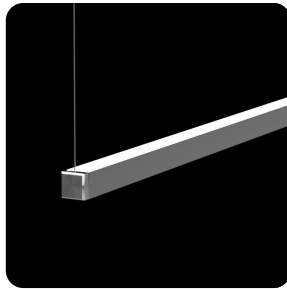
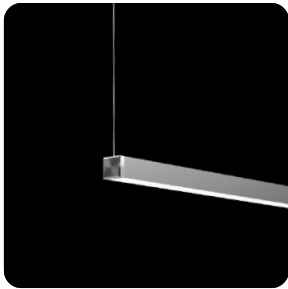

CABLE SUSPENDED (CS)

Power Suspension System. Nitrogen 1 (N1) can be static down-light: Direct (CSD) or static up-light: Indirect (CSI). Standard and custom power cord finishes, sleeve options, and canopy colors offer options to match almost any space. Stainless steel cables come in various lengths (4' is standard) and are field adjustable.

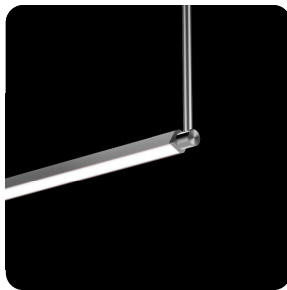
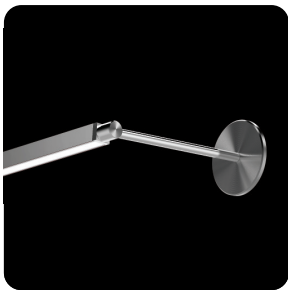

ROTATIONAL ARM MOUNT (RAM)

This system uses 5/8" diameter aluminum arms and subtle details in combination with a 360 degree rotational capacity to create some of the most versatile linear fixtures in the architectural market. Standard mounting uses 3-O mud rings (supplied by others) or a 1" optional trim ring for furniture mounted applications. Engineered with no visible fasteners, smooth rotation, and mechanical locking, the RAM system reveals an impressive aesthetic with exceptional versatility.

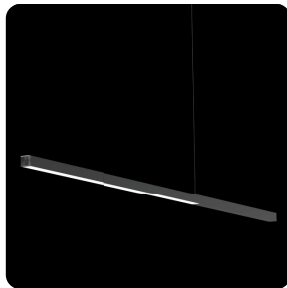
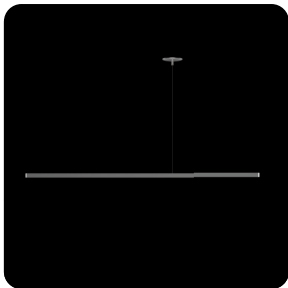

ASYMMETRIC MOUNT (ASM)

A unique configuration where the fixture is balanced from an off-center mounting point creating a dynamic aesthetic. This mounting option also allows some integral ballast options on the "1" series fixtures with standard T5 lamps. Direct, indirect, or rotational options round out this creative mounting option.



SURFACE MOUNT (SM)

Side Mount Side (SMS) or Side Mount Top (SMT). Side, the fixture is mounted on the wall. Top, the fixture is mounted on the ceiling. Both Side and Top give a static down-light. Top or Side Mount specification denotes the power feed location(s). Optional stand-offs allows for fixtures to be mounted from 1/2" to 12" as well as custom lengths if needed.



OPTIONS GUIDE

CONTINUOUS RUN

Continuous runs are available with all fixtures and have several connection options. Single Seam continuous run options offer smooth section transitions while Component Seams lend to a more dramatic visual statement. The 360 Rotational option enables individual sections to rotate independently of each other, which offers adjustable asymmetric light distribution capacity along with striking appearances such as alternating up/down fixtures or spiral transitions. The flexibility within the rotational option makes for infinite design and functional possibilities.



CONTINUOUS RUN
SINGLE SEAM



OXYGEN 2 (O2) WITH A SINGLE SEAM CONTINUOUS RUN

CANOPIES

STANDARD

Canopies have several standard options to suit various environment aesthetics. The standard cable suspension system has 5" Satin White canopies. However, other standard options include a 2" non-power feed canopy option as well as no canopy at all. Both of these include a 5" diameter power feed canopy.

55



5" diameter power feed and 5" diameter non-pow feed canopy. Most common canopy layout. Creates a consistent ceiling aesthetic.

52



5" diameter power feed and 2" diameter non-power feed canopy. Offers a more minimal ceiling treatment while maintaining the ability to cover up mistakes. Requires a 1/4-20 stud securely fastened to the ceiling.

50



5" diameter power feed canopy and no canopy on the non-power feed side. Minimal aesthetic. Requires a 1/4-20 stud securely attached to ceiling. Works well with continuous runs where the power can be carried inside the fixture.

MACHINED

Machined canopies are 4" in diameter and can be anodized as well as powder coated to match a desired color or they can be left with a mill finish for a more striking look. Similar non-power feed options are available with this aesthetic as well. These options do carry a higher cost than standard canopies, but also have an impressive appearance.

44

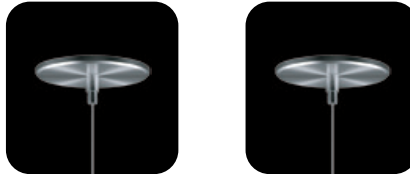

4" diameter machined power feed and 4" diameter machined non-power feed canopy. Offers a consistent ceiling aesthetic with smaller machined canopies. Mill, anodized, and powder coat finishes available.

41



4" diameter machined power feed and 1-1/4" diameter machined non-power feed canopy. Offers minimal ceiling treatment while maintaining the ability to cover mistakes. Requires a 1/4-20 stud securely fastened to the ceiling. Mill, anodized, and powder coat finishes available.

40



4" diameter machined power feed canopy and no canopy on the non-power feed side. Minimal aesthetic. Requires a 1/4-20 stud securely attached to the ceiling. Works well with continuous runs where the power can be carried inside the fixture. Mill, anodized, and powder coat finishes available.

CUSTOM

Custom canopy options are available and can look spectacular in certain applications. Contact the factory with all custom requests or with any questions.

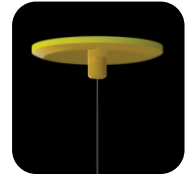

CUSTOM POWDER COAT



CUSTOM ANODIZE



CUSTOM SHAPE



OPTIONS GUIDE

COLOR AND FINISH

Standard finish configurations are Satin Clear (SC) housing with Machined Finish (MF) machined components (end caps, knuckles, cover plates, etc.). The incredibly clean detail within all of the machined components lends to an incredibly high end aesthetic with two tone finish. Numerous custom anodizing and powder coated finishes are available as well. If you have a particular color/finish treatment in mind, please contact the factory and we will do our best to accommodate your project needs.

STANDARD



SATIN CLEAR
ANODIZING

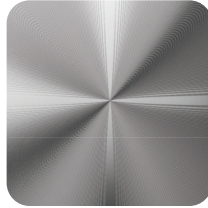

MACHINED
COMPONENTS

CUSTOM



MATTE BLACK



GLOSS BLACK



BRONZE



MILL ALUMINUM



SPECULAR



SATIN WHITE



GLOSS WHITE



COLOR POWDER COAT



COLOR ANODIZE



RAL COLORS

FINISHED CONFIGURATION



THALLIUM 2 (Th2)

Cable Suspended Rotational mount system with two-tone finish, Satin Clear housing and Machined Finish components.

COVER PLATES

Cover plates are standard for Rotational Arm Mounting (RAM) Systems. Standard options are Flat (FT), Curved (CV), or Trim Ring (TR). With certain applications, cover plates or trim rings may not be necessary. Contact factory with questions or for more information. Custom cover plates are also available. If a certain aesthetic is desired, please contact the factory to review any concepts and we will do our best to bring your vision to life.

STANDARD

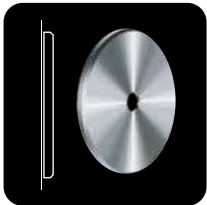

FLAT (CPFT)

Flat has a 4" diameter cover plate for use with a 3-O mud ring.

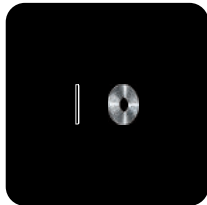

TRIM RING (TR)

1-1/4" diameter trim ring Can be used in applications such as desk mounting.

CUSTOM

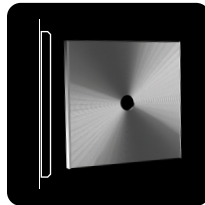

SQUARE

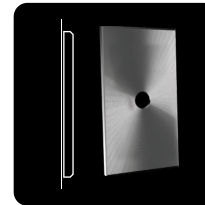

TALL RECTANGLE



CUSTOM

CUSTOM

