

apollo 8



features

8" wide recessed fluorescent luminaire available in 2', 3' & 4' lengths.

1 or 2 lamp T5, T5H0 or T8 lamps provide ambient illumination in a clean architectural design.

Sealed optical compartment for easy cleaning and maintenance.

Radial extruded acrylic diffuser with internal ribs provides low brightness, even illumination and ease of cleaning.

companion luminaires



apollo 8
with exam
function



apollo 1 & 2

dimensional data

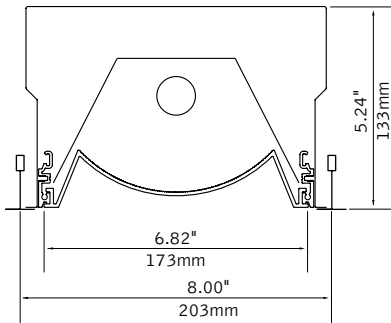

lamping



T5/T5H0

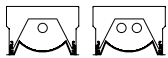

T8

performance

1-Lamp T5
88% Efficiency
1068 cd @ 0°

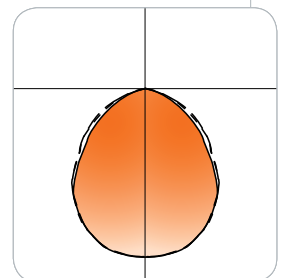

Visit focalpointlights.com for complete photometric data.

fixture:
project:

mounting information

grid

specify "G" for flat 9/16" and 15/16" tee or "ST" for 9/16" slot tee grid types.

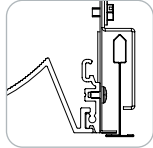

"G" flat tee
Luminaires may be installed in T-bar ceiling systems up to 1 11/16" high.

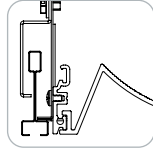

"ST" slot tee

drywall frame kit

specify "DF" Drywall Frame Kit for drywall ceiling conditions.

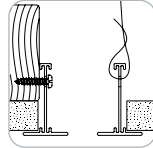

Use tie-wire or screws to secure frame kit.

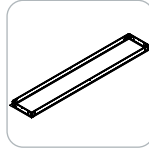

cut out dimensions:
8": Min: 8.3125"
Max: 8.625"
4": Min: 48.325"
Max: 48.6875"

specifications

construction

20 Ga. steel housing.
Lamp compartment is sealed and enclosed by detachable extruded acrylic diffuser.
Bottom access 20 Ga. steel ballast compartment.

weight: 32 lbs

optic

One-piece 20 Ga. steel side reflectors finished in Matte Satin White powder coat.
20 Ga. steel center reflector finished in High reflectance White.

electrical

Ballasts are thermally protected and have a Class "P" rating.
Consult factory for dimming specifications and availability.
UL and cUL listed.

finish

Polyester powder coat applied over a 5-stage pre-treatment.
Optional Anti-Microbial paint finish available.

ordering

luminaire series		FMA8
Apollo 8	FMA8	
nominal size		
8"x2'	82	
8"x3'	83	
8"x4'	84	
shielding		RA
Radial Acrylic Lens	RA	
lamp quantity		
1 Lamp	1	
2 Lamp	2	
lamp type		
T5	T5	
T5H0	T5H0	
T8	T8	
circuits		
Single Circuit	1C	
Dual Circuit	2C	
voltage		
120 Volt	120	
277 Volt	277	
ballast		
Electronic Instant Start <20% THD	E	
Electronic Program Start <10% THD	S	
Electronic Dimming Ballast*	D	
mounting		
Grid Mount	G	
Slot tee	ST	
factory options		
Chicago Plenum	CP	
Drywall Frame Kit	DF	
Emergency Battery Pack*	EM	
Earthquake Clips	EQ	
Single Fuse and Holder	FU	
Flex Whip	FW	
Separate Circuit*	SC	
Separate Circuit Tandem*	SCT	
Labor Saving Master Satellite*	LS	
Ballast Saving Tandem*	BST	
Include 3000K Lamp*	L830	
Include 3500K Lamp*	L835	
Include 4100K Lamp*	L841	
finish		
Matte Satin White	WH	
Matte Satin White Anti-Microbial	WHA	

* for more information see Reference section.

apollo 8



Filename: FMA884RA1T5.IES
 Catalog #: FMA8-84-RA-1-T5-1C-UNV-SG-WH
 Efficiency: 88%
 Test #: 16358

CANDLEPOWER DISTRIBUTION

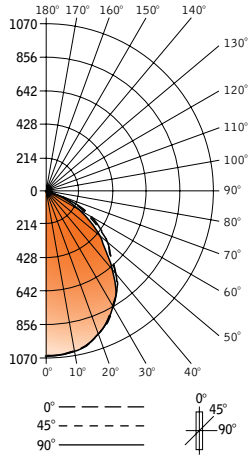

Spacing 1.2
 Criterion: 1.2

Vertical Angle	Horizontal Angle				Zonal Lumens
	0°	22.5°	45°	67.5°	
0°	1068	1068	1068	1068	1068
5°	1067	1067	1067	1067	1067
15°	1030	1033	1035	1039	1039
25°	940	943	952	952	952
35°	797	803	807	797	788
45°	594	599	594	5561	546
55°	445	448	427	389	368
65°	277	271	249	217	205
75°	135	129	111	99	93
85°	33	27	22	21	19
90°	0	0	0	0	0
95°	0	0	0	0	0
105°	0	0	0	0	0
115°	0	0	0	0	0
125°	0	0	0	0	0
135°	0	0	0	0	0
145°	0	0	0	0	0
155°	0	0	0	0	0
165°	0	0	0	0	0
175°	0	0	0	0	0
180°	0	0	0	0	0

LUMEN SUMMARY

Zone	Lumens	% Lamp	% Fixt
0°-30°	834	28.8	32.7
0°-40°	1337	46.1	52.4
0°-60°	2161	74.5	84.8
0°-90°	2550	87.9	100.0
Total Luminaire	2550	87.9	100.0

LUMINANCE DATA (CD/M²)

Vertical Angle	0°	45°	90°
45°	3927	3927	3610
55°	3627	3480	3000
65°	3064	2755	2268
75°	2439	2005	1680
85°	1770	1180	1019

CO-EFFICIENTS OF UTILIZATION

Floor	80	70	20	50	30	10	00
1	97	94	90	88	95	92	86
2	90	84	78	74	88	82	73
3	83	75	68	63	81	73	63
4	76	67	60	55	75	66	54
5	70	60	53	47	68	59	47
6	65	54	47	41	63	53	41
7	60	49	41	36	58	48	36
8	55	44	37	32	54	43	32
9	51	40	32	28	50	39	28
10	47	36	29	25	46	36	25

Go to www.focalpointlights.com for additional photometric data.

apollo 8

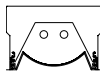

Filename: FMA884RA2T5.IES
 Catalog #: FMA8-84-RA-2-T5-1C-UNV-SG-WH
 Efficiency: 82%
 Test #: 16359

CANDLEPOWER DISTRIBUTION

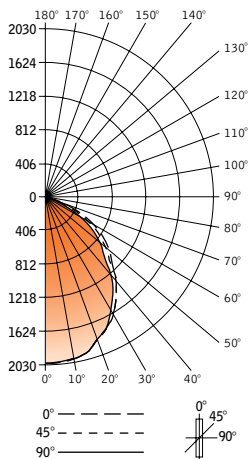

Spacing 1.2
 Criterion: 1.2

Vertical Angle	Horizontal Angle				Zonal Lumens
	0°	22.5°	45°	67.5°	
0°	2033	2033	2033	2033	2033
5°	2013	2014	2013	2013	2014
15°	1955	1956	1958	1958	1958
25°	1772	1774	1775	1769	1763
35°	1493	1498	1487	1452	1432
45°	1131	1139	1105	1049	1020
55°	839	736	788	721	692
65°	520	507	464	409	388
75°	249	232	204	176	169
85°	62	50	41	33	33
90°	0	0	0	0	0
95°	0	0	0	0	0
105°	0	0	0	0	0
115°	0	0	0	0	0
125°	0	0	0	0	0
135°	0	0	0	0	0
145°	0	0	0	0	0
155°	0	0	0	0	0
165°	0	0	0	0	0
175°	0	0	0	0	0
180°	0	0	0	0	0

LUMEN SUMMARY

Zone	Lumens	% Lamp	% Fixt
0°-30°	1567	27.0	32.9
0°-40°	2493	43.0	52.4
0°-60°	4037	69.6	84.9
0°-90°	4756	82.0	100.0
Total Luminaire	4756	82.0	100.0

LUMINANCE DATA (CD/M²)

Vertical Angle	0°	45°	90°
45°	7478	7306	6744
55°	6839	6423	5640
65°	5752	5133	4292
75°	4498	3685	3053
85°	3326	2199	1770

CO-EFFICIENTS OF UTILIZATION

Floor	80	70	20	50	30	10	00
1	91	87	84	82	89	86	80
2	84	78	73	69	82	76	68
3	77	70	64	59	75	69	59
4	71	63	56	51	70	62	51
5	66	56	49	44	64	55	44
6	61	50	44	39	59	50	39
7	56	46	9	34	55	45	34
8	52	41	34	30	50	40	30
9	48	37	30	26	46	36	26
10	44	34	27	23	43	33	23

Go to www.focalpointlights.com for additional photometric data.

apollo 8



Filename: FMA884RA1T8.IES
 Catalog #: FMA8-84-RA-1-T8-1C-UNV-SG-WH
 Efficiency: 76%
 Test #: 16357

CANDLEPOWER DISTRIBUTION

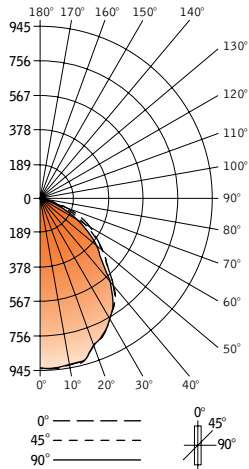

Spacing 1.2
 Criterion: 1.2

Vertical Angle	Horizontal Angle				Zonal Lumens
	0°	22.5°	45°	67.5°	
0°	939	939	939	939	939
5°	943	943	943	943	943
15°	925	925	927	930	932
25°	829	831	836	840	836
35°	711	715	717	706	702
45°	516	525	514	487	472
55°	389	389	368	334	322
65°	241	237	212	185	176
75°	115	106	92	79	77
85°	26	20	18	15	15
90°	0	0	0	0	0
95°	0	0	0	0	0
105°	0	0	0	0	0
115°	0	0	0	0	0
125°	0	0	0	0	0
135°	0	0	0	0	0
145°	0	0	0	0	0
155°	0	0	0	0	0
165°	0	0	0	0	0
175°	0	0	0	0	0
180°	0	0	0	0	0

LUMEN SUMMARY

Zone	Lumens	% Lamp	% Fixt
0°-30°	739	25.1	33.2
0°-40°	1186	40.2	53.2
0°-60°	1902	64.5	85.3
0°-90°	2229	75.6	100.0
Total Luminaire	2229	75.6	100.0

LUMINANCE DATA (CD/M²)

Vertical Angle	0°	45°	90°
45°	3412	3398	3121
55°	3171	3000	2625
65°	2666	2345	1947
75°	2077	1662	1391
85°	1395	966	805

CO-EFFICIENTS OF UTILIZATION

Floor	80	70	20	50	30	10	00
RCR 0	90	90	90	88	88	84	84
1	84	81	78	75	82	79	74
2	77	72	68	64	75	71	63
3	71	65	59	55	70	63	54
4	66	58	52	47	64	57	47
5	61	52	45	41	59	51	41
6	56	47	40	36	55	46	36
7	52	42	36	32	50	42	31
8	48	38	32	28	47	37	28
9	44	34	28	24	43	34	24
10	41	31	25	21	40	31	21

Go to www.focalpointlights.com for additional photometric data.

Numbers indicate percentage values of reflectivity.

apollo 8

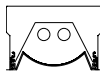

Filename: FMA884RA2T8.IES
 Catalog #: FMA8-84-RA-2-T8-1C-UNV-SG-WH
 Efficiency: 67%
 Test #: 16356

CANDLEPOWER DISTRIBUTION

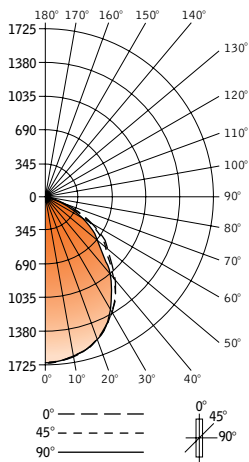

Spacing 1.2
 Criterion: 1.2

Vertical Angle	Horizontal Angle				Zonal Lumens
	0°	22.5°	45°	67.5°	
0°	1723	1723	1723	1723	1723
5°	1702	1701	1707	1699	1701
15°	1634	1636	1634	1634	1632
25°	1477	1477	1475	1465	1458
35°	1243	1245	1229	1198	1180
45°	939	941	909	857	834
55°	693	689	649	588	562
65°	427	415	378	330	314
75°	204	190	165	144	136
85°	50	41	33	29	29
90°	0	0	0	0	0
95°	0	0	0	0	0
105°	0	0	0	0	0
115°	0	0	0	0	0
125°	0	0	0	0	0
135°	0	0	0	0	0
145°	0	0	0	0	0
155°	0	0	0	0	0
165°	0	0	0	0	0
175°	0	0	0	0	0
180°	0	0	0	0	0

LUMEN SUMMARY

Zone	Lumens	% Lamp	% Fixt
0°-30°	1307	22.1	33.3
0°-40°	2073	35.1	52.8
0°-60°	3342	56.6	85.1
0°-90°	3928	66.6	100.0
Total Luminaire	3928	66.6	100.0

LUMINANCE DATA (CD/M²)

Vertical Angle	0°	45°	90°
45°	6208	6010	5514
55°	5649	5290	4581
65°	4724	4182	3474
75°	3685	2980	2457
85°	2682	1770	1556

CO-EFFICIENTS OF UTILIZATION

Floor	80	70	20	50	30	10	00
RCR 0	79	79	79	77	77	74	74
1	74	71	69	66	72	70	65
2	68	63	59	56	66	62	56
3	63	57	52	48	61	56	48
4	58	51	46	42	57	50	41
5	53	45	40	36	52	45	36
6	49	41	36	32	48	40	31
7	46	37	32	28	44	37	28
8	42	33	28	24	41	33	24
9	39	30	25	21	38	30	21
10	36	27	22	19	35	27	19

Go to www.focalpointlights.com for additional photometric data.

Numbers indicate percentage values of reflectivity.