

DESCRIPTION

The Continua™ suspended linear provides a fresh modern aesthetic with minimal lines and seamless illumination along the entire row length up to 100 feet. Combining the latest LED technology with precision engineered optical control, the Continua provides high quality illumination while maximizing spacing capabilities and delivering up to 147 lumens per watt. A wide range of direct/indirect distributions are available to choose from as well as independent up/down circuiting for ultimate flexibility. Available in 4', 8', 12', and continuous runs, the Continua is well suited for commercial open offices, private offices, conference rooms, corridors, and educational facilities.

SPECIFICATION FEATURES

Construction

Nominal 2.4" x 7" housing constructed from extruded aluminum with die-formed 22 gauge cold rolled steel gear tray.

End Caps

Precision engineered die cast aluminum end caps attach mechanically to the end of the fixture without exposed fastener. End cap adds 2" at each end.

Light Engine

LED's are available in 3000K, 3500K or 4000K with CRI options of either ≥80CRI or ≥90CRI. Lumen output will be affected - please refer to the lumen adjustment factor table.

Electrical

Long-Life LED system coupled with integral electronic drivers to deliver optimal performance. Standard with 120-277V 0-10V dimming drivers (1% standard). 347V 0-10V drivers are available. Dimming wires come standard but can be capped in the field for standard switched operation. A single power feed drop supplied as standard.

Controls

Options compatible with Eaton's Connected Lighting Systems:

- WaveLinX sensor
- LumaWatt Pro sensor
- Fifth Light DALI driver

Refer to the Connected Lighting options page and ordering information for more details.

Mounting

Aircraft cable mounts on 4'-0", 8'-0" and 12'-0" centers and can also be adjusted along the length of the fixture to match existing mounting points. Minimum suspension height from ceiling to top of fixture is 5". Fixture is balanced to allow for minimal leveling. All sections are continuously wired with push-in connectors for fast installation. Fixtures can be joined for straight continuous runs with supplied alignment pins and internal cast joiners. Refer to installation instructions for various ceiling interface details.

Finish

Electrostatically applied polyester powder coat paint in white, silver, or black. RAL custom colors are available.

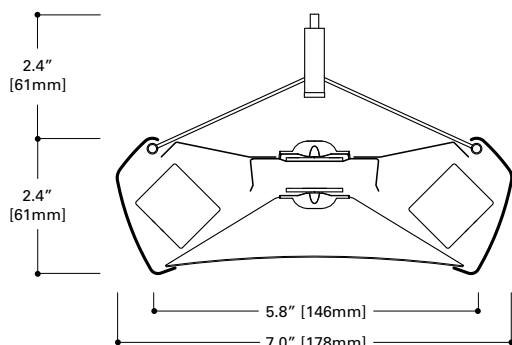

CONTINUA - CTA LED

Suspended
Direct / Indirect

cULus – 1598
Damp Location Listed
LM79/LM80 Compliant
ROHS Compliant
DesignLights Consortium™ Qualified



ORDERING INFORMATION

Sample Number: CTA-F-7525-40L835-1D-UNV-STD-SWPD1-W-AC48-UM-36

Series	Shielding	Distribution (%Up / %Down)	Lumen Package (Nominal Lms per 4' section)	Color Temperature	Circuiting	Specialty Wiring	Input Voltage
CTA = Continua Suspended LED	F = Frosted Continuous Roll Lens	7525 = 75% / 25% 5050 = 50% / 50% 2575 = 25% / 75% 0100 = 0% / 100% — = Specify Up/Down Distribution	20L = 2,000 Lms (500 lms/ft) 30L = 3,000 Lms (750 lms/ft) 40L = 4,000 Lms (1,000 lms/ft) 50L = 5,000 Lms (1,250 lms/ft) 60L = 6,000 Lms (1,500 lms/ft)	830 = 3000K, 80 CRI 835 = 3500K, 80 CRI 840 = 4000K, 80 CRI 930 = 3000K, 90 CRI 935 = 3500K, 90 CRI 940 = 4000K, 90 CRI	1 = Single Circuit 2 = Dual Circuit - (Ind. Up/Down Circuits)	D = None (Default Dimming) E = Emergency Circuit S = Secondary Circuit	UNV = Universal (120V-277V) 347 = 347V
	Single piece lens supplied up to 100-ft.	Not all distributions are available; consult factory for more details.	Refer to performance table on Page 3 for more detail. 20L not available with 7525 distribution in a 4' luminaire. 20L and 30L not available with 2575 distribution in a 4' luminaire.	Additional lead-time may apply for 930, 935 and 940 configurations.	Refers to wiring in cross section. Dual circuit not available with secondary circuit or integrated sensor.	Select "D" wiring for individual fixtures. Emergency and Secondary circuit section wiring are configured per unit (4ft, 8ft, or 12ft). Secondary circuit not available with integrated sensor options.	Integral 347V driver with STD 0-10V option only. Factory supplied 347V remote transformer for all other driver options.

Driver/Dimming Options	Integral Sensor (Optional)	Integral Emergency Device (Optional)	Finish	Suspension/ Power Feed	Suspension Length	Ceiling Type	Run Length
STD = Standard 0-10V (1%-100%) SR = Sensor Ready (1%-100%) 5LT = Fifth Light DALI (5%-100%) LH = Lutron HiLume 1% EcoSystems L5 = Lutron 5-Series 5% EcoSystems	SWPD1 = WaveLinX Wireless Integrated Sensor LWIPD1 = LumaWatt Pro Wireless Integrated Sensor	ILB12 = 12-watt, 120V-277V Iota ILB-SL-CP12 EPC = UL924 Bypass Relay	W = White S = Silver B = Black CC = Custom Color	AC = Aircraft cable with straight power cord	<u>Adjustable Cable</u> 48", 120", 240", 300", or 360"	UM = Universal Ceiling Kit TS = Slotted T-Bar	4 = 4 ft. 8 = 8 ft. 12 = 12 ft. XX = Specify Row Length
Additional driver configuration information on Page 4.	SW sensor must be used with "STD" driver. LWI sensor must be used with "SR" sensor ready driver. Integrated Sensors combined with Emergency Circuit require one UL924 Bypass Relay per emergency fixture.			UM ceiling type accommodates 1" Grid (T1), 9/16" Grid (T9), 4" Octagonal J-Box (JB), and Structure (ST). White mounting hardware standard; for black mounting hardware, add "-B" after ceiling type.			Standard row configurations over 12' consist of 8' and 12' luminaires.

Lengths

Available in 4-ft, 8-ft, and 12-ft sections. All sections are modular eliminating the need for starter, joiner and end sections. Standard row configurations over 12-ft consist of 8-ft and 12-ft luminaires unless otherwise specified.

Optics

Precision engineered acrylic TIR optics on upper and lower LED light engines for optimal light distribution and uniformity. 112.5° peak candela angle.

Shielding

Frosted continuous flexible roll out lens creates seamless illumination along the entire specified row length. Single piece lens available in lengths up to 100 ft.

Lumen Maintenance

Projected lumen maintenance based on TM-21 standards is L84 > 60,000 hours at 25°C ambient conditions.

Emergency Options

Emergency circuit option operates all down-light sections of a specified unit (4-ft, 8-ft, or 12-ft). Optional 120V-277V integral emergency battery pack is 12W maximum, 90 minute output, and illuminates a 4 ft. down-light section during loss of normal power; 1200 lumens delivered. Test switch/indicator button located on the top side of the luminaire. The combination of integrated sensor and emergency circuit options require an EPC UL924 bypass relay that disables sensor control of emergency fixtures when normal power is lost.

Integrated Sensing and Control Systems

Integrated options must be used in conjunction with the associated system and may not be compatible with other options or accessories. Please consult WaveLinX and LumaWatt Pro system pages for additional details and compatibility. Consult Marketplace Options - Lutron system pages for additional details and compatibility. Requires field commissioning to operate or dim. Contact Lutron at www.lutron.com.

Weight

4.5 lbs per foot.

Compliance

Modules are UL recognized components and indoor luminaires are cULus listed for 25°C ambient environments, damp location listed, and RoHS compliant. LED modules comply with IESNA LM-79 and LM-80 standards. DesignLights Consortium™ Qualified and classified for DLC Standard and DLC Premium, refer to www.designlights.org for details.

Warranty

Five year warranty.

FIXTURE LENGTHS

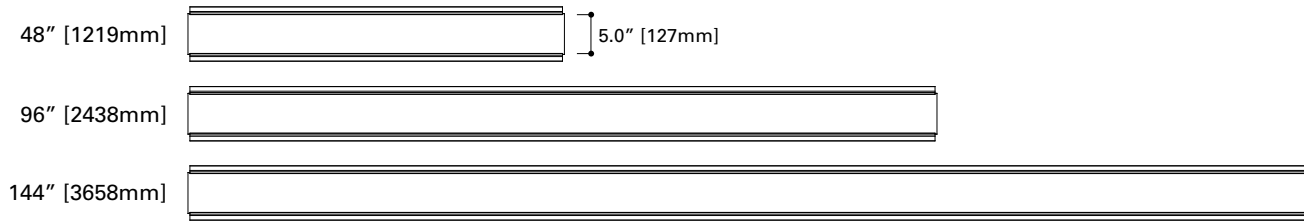

SENSOR OPTIONS

Integrated sensors are located in the middle of each 8' and 12' section and on the end of 4' sections for individual and continuous runs. Minor field adjustments of the sensor location are possible along the length of the fixture. Each section can be individually controllable or grouped together with the integrated sensors.

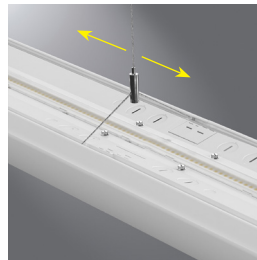

VARIABLE MOUNTING POINTS

Navigate existing ceiling obstructions with variable mounting locations that slide continuously along the length of the fixture. Ideal for retrofit applications.

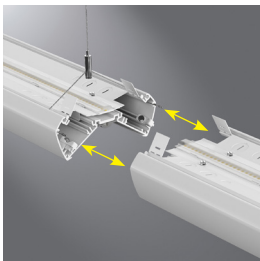

RIGID JOINING

Thoughtfully designed joining features ensure that long continuous runs will not bow or snake. Alignment pins and cast joiners at every joint create rigid and tight connections between fixtures.

Continua Suspended Performance (3500K)								
Series/ Distribution	Lumen Package	Delivered Lumens				Wattage		Efficacy LPW
		4FT	Per FT	↑ Per FT	↓ Per FT	4FT	Per FT	
CTA 75/25	20L	2300	575	414	161	N/A		
	30L	3045	761	568	193	23	5.7	133
	40L	3993	998	746	253	30	7.5	134
	50L	5061	1265	940	325	38	9.4	135
	60L	6053	1513	1131	382	46	11.5	132
CTA 50/50	20L	2180	545	269	276	19	4.7	117
	30L	3019	755	382	373	25	6.2	121
	40L	3974	994	483	511	33	8.2	122
	50L	5052	1263	631	633	42	10.4	122
	60L	6090	1523	765	758	51	12.7	120
CTA 25/75	20L	2276	569	171	398	N/A		
	30L	3062	765	207	559	N/A		
	40L	4092	1023	285	738	38	9.5	108
	50L	5030	1258	327	931	48	12.0	105
	60L	6103	1526	417	1109	59	14.8	103
CTA 0/100	20L	2058	515	0	515	21	5.2	99
	30L	3055	764	0	764	32	8.0	96
	40L	4016	1004	0	1004	44	10.9	92
	50L	5358	1340	0	1340	63	15.8	85
	60L	6039	1510	0	1510	73	18.2	83

8 ft.*			12 ft.*		
Wattage		Efficacy LPW	Wattage		Efficacy LPW
8FT	Per FT		12FT	Per FT	
32	4.0	143	47	3.9	147
48	6.0	127	70	5.8	131
57	7.2	139	83	6.9	144
72	9.0	140	104	8.7	145
88	11.0	138	131	10.9	139
36	4.5	122	52	4.3	126
53	6.6	114	77	6.5	117
64	8.0	124	93	7.7	128
82	10.2	124	119	9.9	127
99	12.3	124	147	12.3	124
38	4.8	119	57	4.7	121
54	6.8	113	79	6.5	117
74	9.2	111	110	9.2	111
93	11.6	108	141	11.7	107
119	14.8	103	177	14.7	103
39	4.8	106	58	4.8	107
63	7.8	98	94	7.8	98
86	10.7	93	131	10.9	92
112	14.0	96	168	14.0	96
138	17.3	87	207	17.3	87

*Delivered lumens for 8ft and 12ft units are multiples of 4ft values. Input wattages per foot vary per unit length.

LUMEN ADJUSTMENT FACTORS

CCT	80 CRI	90 CRI
3000K	0.964	0.830
3500K	1.000	0.861
4000K	1.015	0.883

Example Calculation:

7525 / 40L / 3500K / 80 CRI

Lumen Output selected = 998 lms/ft

3500K / 90 CRI Desired

Lumen Adjustment Factor = 0.861

Adjusted Lumen Output = 998 lms/ft x 0.861 = 859 lms/ft

LUMEN MAINTENANCE

Ambient Temperature	TM-21 Lumen Maintenance (60,000 hours)	Theoretical L70 (Hours)
25°C	>84%	121,000

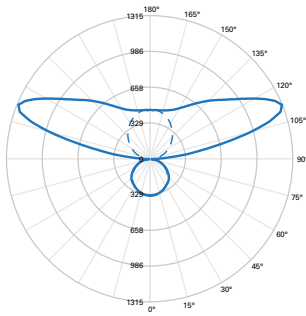

FILE NAME: CTA-F-7525-40L835-UNV-4.IES

ZONAL LUMENS SUMMARY

LUMINANCE DATA (CD/M²)

CCT: (LD5) LED 3500K
LUMENS: 3993 Lm
WATTS: 29.8 W
EFFICACY: 134 Lm/W
TEST NO.: G2-1709-282-2
75% UP / 25% DOWN

Zone	Lumens	% Fixture
0°-30°	261	6.5
0°-90°	1011	25.3
90°-130°	1945	48.7
90°-180°	2983	74.7
0°-180°	3993	100

Vertical Angle	0°		
	0°	45°	90°
45°	2035	2089	2190
55°	1968	2137	2126
65°	1908	2061	2030
75°	1820	1944	1919
85°	1629	1851	1703

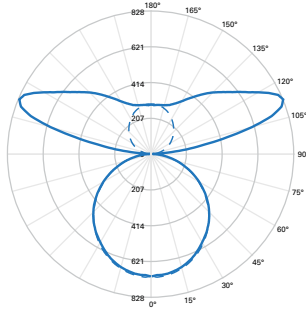
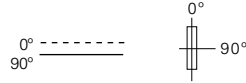

FILE NAME: CTA-F-5050-40L835-UNV-4.IES

ZONAL LUMENS SUMMARY

LUMINANCE DATA (CD/M²)

CCT: (LD5) LED 3500K
LUMENS: 3974 Lm
WATTS: 32.7 W
EFFICACY: 122 Lm/W
TEST NO.: G2-1709-282-7
49% UP / 51% DOWN

Zone	Lumens	% Fixture
0°-30°	550	13.8
0°-90°	2044	51.4
90°-130°	1260	31.7
90°-180°	1931	48.6
0°-180°	3974	100

Vertical Angle	0°		
	0°	45°	90°
45°	4261	4297	4307
55°	4083	4196	4162
65°	3878	3984	3939
75°	3615	3639	3590
85°	2961	2961	2665

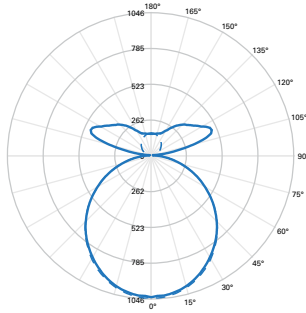

FILE NAME: CTA-F-2575-40L835-UNV-4.IES

ZONAL LUMENS SUMMARY

LUMINANCE DATA (CD/M²)

CCT: (LD5) LED 3500K
LUMENS: 4092 Lm
WATTS: 37.9 W
EFFICACY: 108 Lm/W
TEST NO.: G2-1709-282-12
28% UP / 72% DOWN

Zone	Lumens	% Fixture
0°-30°	801	19.6
0°-90°	2951	72.1
90°-130°	752	18.4
90°-180°	1141	27.9
0°-180°	4092	100

Vertical Angle	0°		
	0°	45°	90°
45°	6195	6195	6168
55°	5928	5973	5928
65°	5649	5679	5618
75°	5160	5210	5085
85°	4219	4145	3701



COLOR DATA (3500K)

		80CRI
TM-30-15	R _f	82.3
	R _g	97.6
CRI/CIE	R _a	83.0
	R _g	13.8

Driver Availability Table – ‘STD’ 0-10V, UNV # of Drivers				
Distribution	Lumen Package	4’	8’	12’
75/25	20L	N/A	2	2
	30L	2	2	2
	40L	2	2	2
	50L	2	2	2
	60L	2	2	2
50/50	20L	2	2	2
	30L	2	2	2
	40L	2	2	2
	50L	2	2	2
	60L	2	2	2
25/75	20L	N/A	2	2
	30L	N/A	2	2
	40L	2	2	2
	50L	2	2	3
	60L	2	3	4
0/100	20L	1	1	1
	30L	1	1	1
	40L	1	1	2
	50L	1	2	3
	60L	1	2	3

Driver Availability Table – ‘5LT’ DALI / ‘SR’ # of Drivers				
Distribution	Lumen Package	4’	8’	12’
75/25	20L	N/A	2	2
	30L	2	2	2
	40L	2	2	2
	50L	2	2	2
	60L	2	2	3
50/50	20L	2	2	2
	30L	2	2	2
	40L	2	2	2
	50L	2	2	2
	60L	2	2	3
25/75	20L	N/A	2	2
	30L	N/A	2	2
	40L	2	2	3
	50L	2	2	3
	60L	2	3	4
0/100	20L	1	1	1
	30L	1	1	2
	40L	1	2	3
	50L	1	2	3
	60L	1	2	3

Driver Availability Table – ‘L5’ / ‘LH’ Lutron # of Drivers				
Distribution	Lumen Package	4’	8’	12’
75/25	20L	N/A	N/A	N/A
	30L	N/A	N/A	2
	40L	N/A	2	2
	50L	N/A	2	2
	60L	N/A	2	3
50/50	20L	N/A	N/A	2
	30L	N/A	2	2
	40L	N/A	2	2
	50L	N/A	2	2
	60L	2	2	3
25/75	20L	N/A	N/A	N/A
	30L	N/A	N/A	N/A
	40L	N/A	N/A	3
	50L	N/A	N/A	3
	60L	N/A	3	4
0/100	20L	1	1	1
	30L	1	1	2
	40L	1	2	3
	50L	1	2	3
	60L	1	2	3

Driver Availability Table – ‘STD’ 0-10V, 347V # of Drivers				
Distribution	Lumen Package	4’	8’	12’
75/25	20L	N/A	2	2
	30L	2	2	2
	40L	2	2	2
	50L	2	2	3
	60L	2	2	3
50/50	20L	2	2	2
	30L	2	2	2
	40L	2	2	2
	50L	2	2	3
	60L	2	2	3
25/75	20L	N/A	2	2
	30L	N/A	2	3
	40L	2	2	3
	50L	2	3	4
	60L	2	3	4
0/100	20L	1	1	1
	30L	1	2	3
	40L	1	2	3
	50L	1	2	3
	60L	2	N/A	N/A