

FEATURES & SPECIFICATIONS

INTENDED USE

The **Alcon Lighting i66 Series Architectural LED Surface Mount Linear Lighting** fixtures bring clean lines and clear light to commercial LED or residential office lighting interiors. Our sleek, stylish fixtures offer highly effective and efficient lighting solutions for hotels, offices, retail outlets, restaurants, and more.

DETAILS

**8 FT - W 6" x L 96" x H 6"**

**Construction:** Die-formed and welded 22-gauge cold rolled steel

**Lens:** Snap In Frosted Acrylic

ADDITIONAL FEATURES

**Type:** Direct Downlight

**Voltage:** 120-277

**Wattage:** 72W (4x18W)

**Lumens:** 8400 lms

**CRI:** 83

**Life:** 50,000 Hours

**Listings:** ETL and DLC for LED component only  
LED lamp included

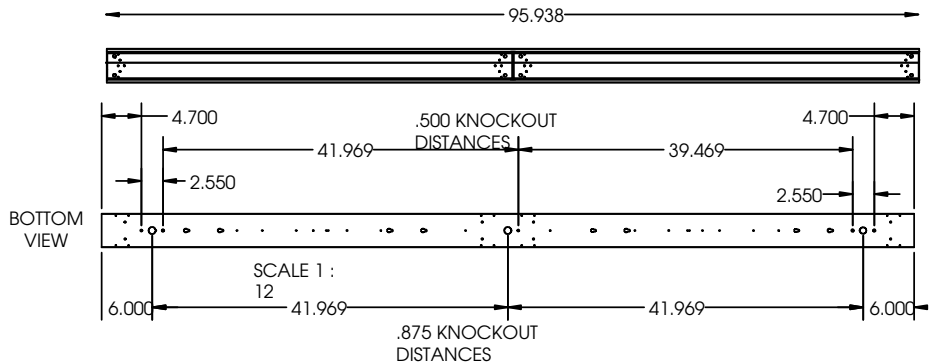
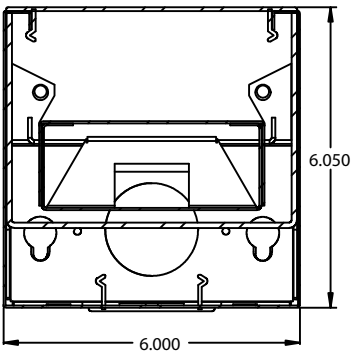
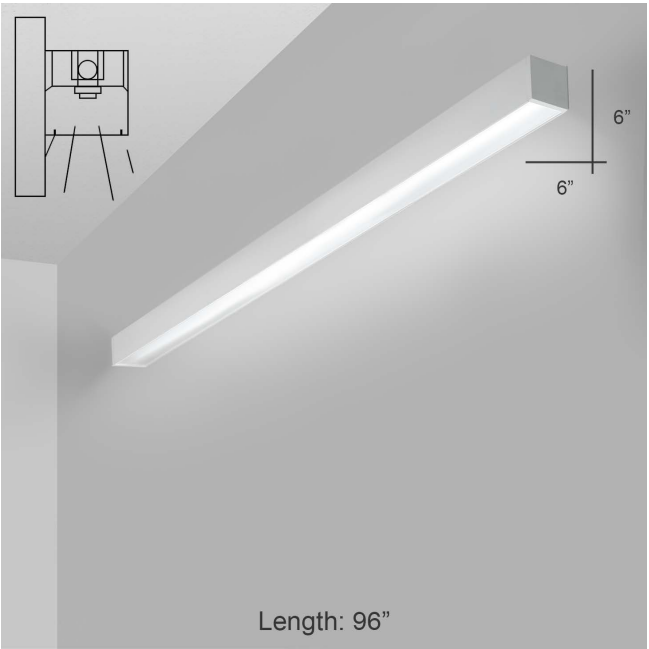

Ordering Information:

Example: (11142-8-W-40K-WH-2W-DS)

Model	Color Temp	Finish	Dimming	Options
<input type="text"/>	<input type="text"/>	<input type="text"/>	<input type="text"/>	<input type="text"/>
<b>11142-8-W</b> Wall Mount	<b>35K</b> 3500K <b>40K</b> 4000K <b>50K</b> 5000K	<b>WH</b> White <b>BK</b> Black <b>SL</b> Silver <b>BR</b> Bronze	<b>Blank</b> Non-Dimming (Standard) <b>2W</b> 2-Wire Incandescent Dimming (120V only) (Title 24 Compliant)	<b>CRWK</b> Continuous Row Wire Kit <b>EM<sup>1</sup></b> Emergency Backup Battery <b>DS<sup>1</sup></b> Integrated Daylight Sensor

<sup>1</sup> Factory Installed