

FEATURES & SPECIFICATIONS

INTENDED USE

The **Alcon Lighting i66 Series Architectural LED Surface Mount Linear Lighting** fixtures bring clean lines and clear light to commercial LED or residential office lighting interiors. Our sleek, stylish fixtures offer highly effective and efficient lighting solutions for hotels, offices, retail outlets, restaurants, and more.

DETAILS

2 FT - W 6" x L 24" x H 6"

Construction: Die-formed and welded 22-gauge cold rolled steel

Lens: Snap In Frosted Acrylic

ADDITIONAL FEATURES

Type: Direct Downlight

Voltage: 120-277

Wattage: 30W (2x15W)

Lumens: 3400 lms

CRI: 83

Life: 50,000 Hours

Listings: ETL and DLC for LED component only
LED lamp included

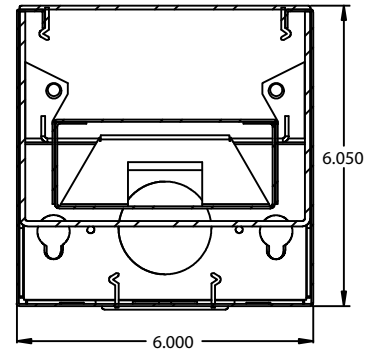
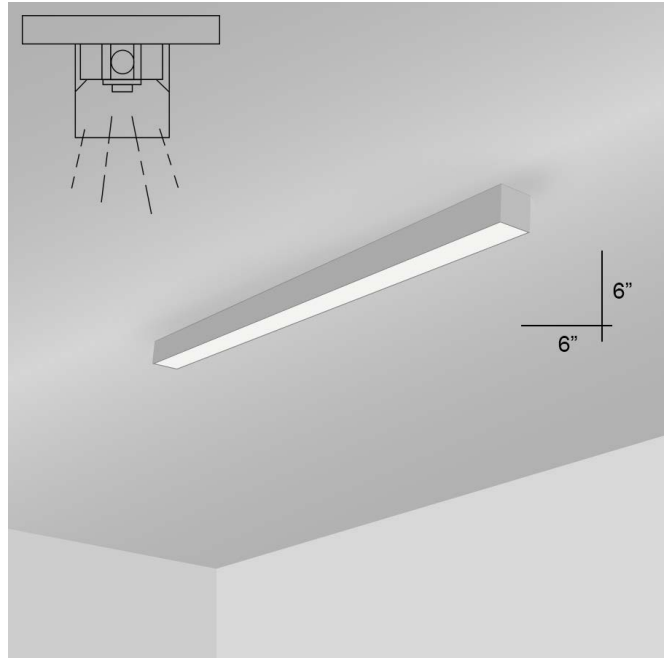

Ordering Information:

Example: (11139-2-S-40K-WH-2W-DS)

Model	Color Temp	Finish	Dimming	Options
<input type="text"/>	<input type="text"/>	<input type="text"/>	<input type="text"/>	<input type="text"/>
11139-2-S Surface	35K 3500K 40K 4000K 50K 5000K	WH White BK Black SL Silver BR Bronze IR Iron	Blank Non-Dimming (Standard) 2W 2-Wire Incandescent Dimming (120V only) (Title 24 Compliant)	CRWK Continuous Row Wire Kit EM¹ Emergency Backup Battery DS¹ Integrated Daylight Sensor

¹Factory Installed