

INSTALLATION INSTRUCTIONS FOR 14100-4RR

ITEM NO.	PART NUMBER	DESCRIPTION	QTY.
1	14100-4RRSF24LR24W2400LD MV1IC90		1
2	14100-4RRSF12LR12W1200LD MV1IC90		1
3	23_CRNR_JOINER_S_A SSY		1

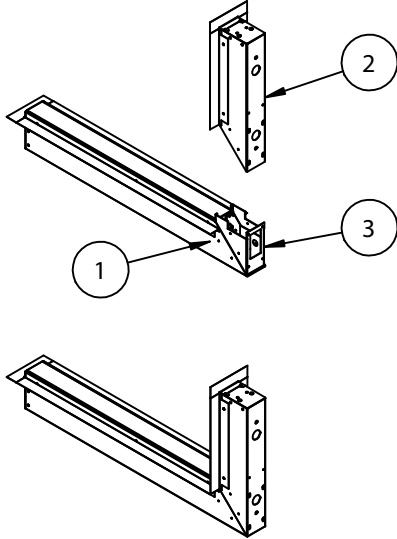

FIRST ATTACH THE SECOND FIXTURE TO THE FIRST FIXTURE, BY SLIDING THE SECOND FIXTURE ONTO THE CORNER JOINER (THAT IS ALREADY WELDED INTO THE FIRST FIXTURE.) ONCE THE TWO FIXTURES ARE LINED UP, USE SCREWS IN THE BACK OF THE SECOND FIXTURE TO ATTACH TIGHTLY.

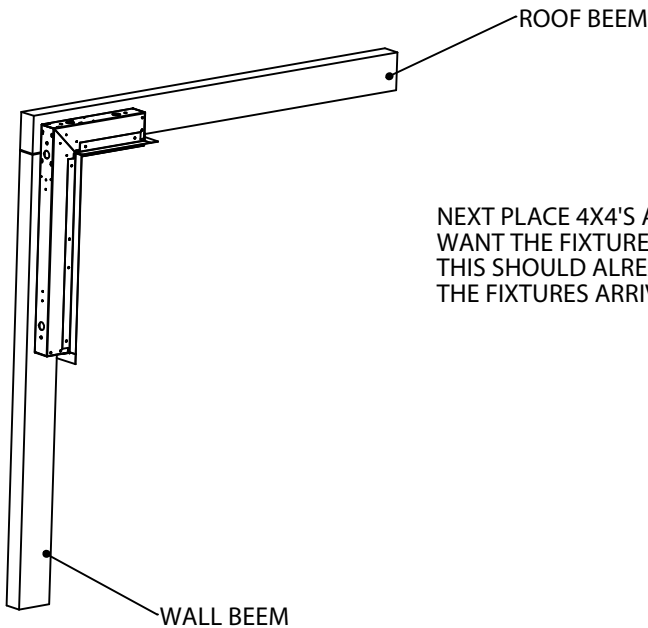

NEXT PLACE 4X4'S ALONG SIDE THE PATH YOU WANT THE FIXTURE TO TAKE. IN MOST CASES THIS SHOULD ALREADY BE FINISHED BY THE TIME THE FIXTURES ARRIVE ON SITE.



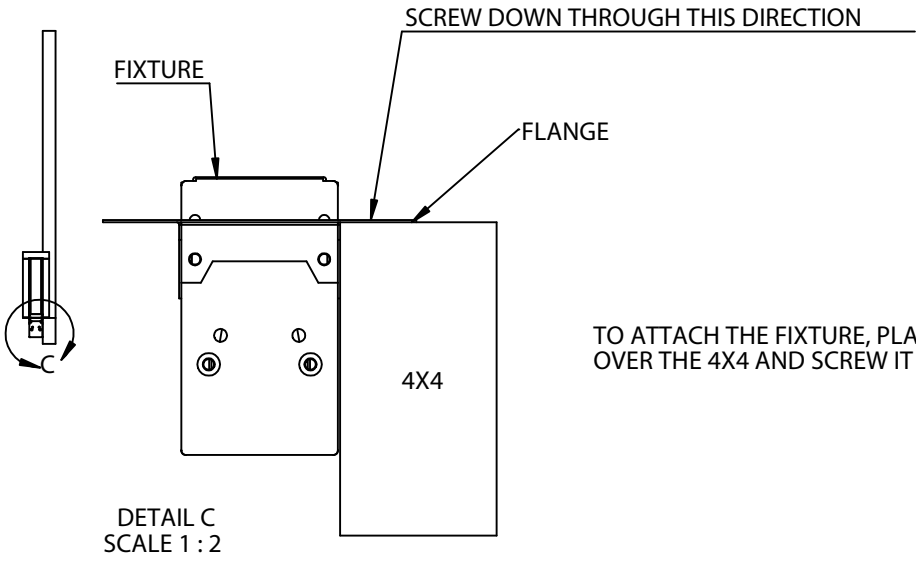

TO ATTACH THE FIXTURE, PLACE THE FLANGE OVER THE 4X4 AND SCREW IT DOWN.

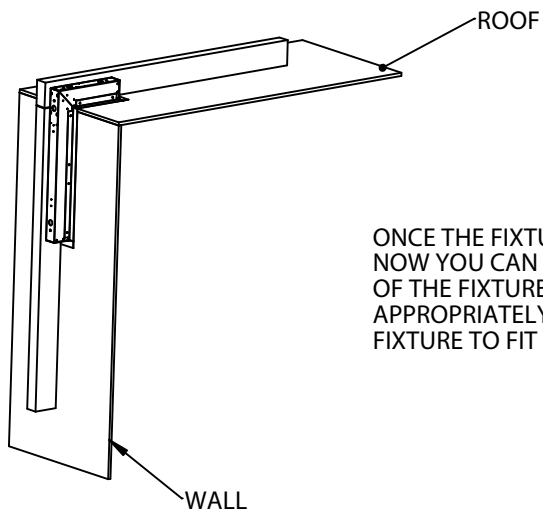

ONCE THE FIXTURES ARE IN PLACE AND WIRED UP. NOW YOU CAN PLACE DRYWALL OVER THE FRONT OF THE FIXTURE, BUT REMEMBER TO CUT OUT AN APPROPRIATELY SIZED SPACE FOR THE FACE OF THE FIXTURE TO FIT THROUGH.

