

Project Name: \_\_\_\_\_ Type: \_\_\_\_\_ Quantity: \_\_\_\_\_

### INTENDED USE

This RGBW LED landscape lighting provides precise, dimmable color tuning control and compatibility with Amazon Alexa and Google Home. The directional uplight features a corrosion-resistant cast brass housing finished in naturally toned gun metal. The clear glass lens ensures excellent light distribution, sealed with a water-tight silicone double gasket to withstand the elements.

### FEATURES

- Construction:** Corrosion Resistant Cast Brass
- Finish:** Gun Metal
- Lens:** Clear flat (non-Shroud) | Clear Convex Glass for Medium and Large Shroud.
- Gasket:** Silicone double gasketed for water-tight sealing.
- Knuckle:** Swivel cast brass with thumb screw and 1/2" NPT threaded male hub on bottom.
- Cord:** 10'
- Beam spread:** 38° Standard (15° & 60° options included).
- Color temperature:** Offered in 2700K, 3000K, 4000K, 5000K and RGB unlimited color wheel options & quick presets. Customizable scenes with up to 8 colors. Compatibility with Amazon's Alexa and Google Home. The lights will follow music collected by a phone microphone.
- RGBW Smart Phone App:** Bluetooth App for iOS and Android (See Page 3)
- CRI:** >85
- Voltage:** 12-15V
- Lumen Output:** 15LM-45OLM (RGB+CCT) from 1-6 Watts
- Operating temperature:** -40°F to 124°F
- Warranty:** Five year warranty carefree for parts & components (Labor not included).



No-Shroud  
9170



Medium Shroud  
9170-MS



Large Shroud  
9170-LS



### ORDERING INFORMATION Example:

Model	Shroud	Mount Type	Options
9170	<b>Blank</b> No Shroud <b>MS</b> Medium Shroud <b>LS</b> Large Shroud	<b>Blank</b> 8.5" ABS Spike, 1/2" NPT <sup>Standard</sup> <b>P1</b> 1" PVC Pedestal <b>P3</b> 3" PVC Pedestal <b>TB</b> Tree Mounting Bracket <b>SC</b> <sup>1</sup> 5" Surface canopy  Path Lighting Applications: <b>S18</b> <sup>2</sup> 18" Single Head Post <b>D18</b> <sup>2</sup> 18" Double Head Post <b>S24</b> <sup>2</sup> 24" Single Head Post <b>D24</b> <sup>2</sup> 24" Double Head Post	<b>WBG</b> <sup>3</sup> Wireless Bluetooth Mesh Gateway <b>BRE</b> Bluetooth Range Extender

<sup>1</sup> 5" Canopy is required for sign light installation in addition to any of the posts (S18, D18, S24, or D24.)  
<sup>2</sup> Mounting Posts are ideal for Sign Light & Path Light Applications.  
<sup>3</sup> Ideal for scheduling and automation with remote lighting control.

## MOUNTING

### Ground Spikes

Injection molded 8 1/2" h x 3" w ABS Spike, 1/2" NPT (standard).

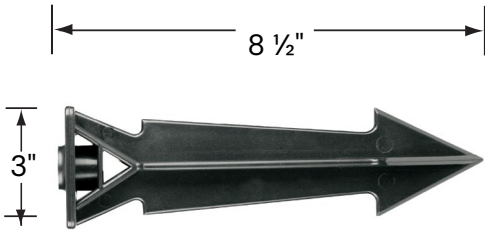

### Mounting Pedestals

**P1** 1" PVC Mounting Pedestal, 1/2" NPT, Black

**P3** 3" PVC Mounting Pedestal, 1/2" NPT Female Brass Hub on top, Black

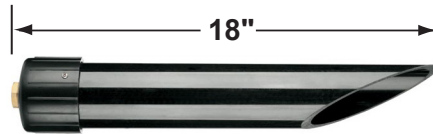

### Mounting Posts

\*SC (Surface Canopy) is required for sign light installation



**S24**

24" Single Head Post, Gun Metal

**D24**

24" Double Head Post, Gun Metal

**S18**

18" Single Head Post, Gun Metal

**D18**

18" Double Head Post, Gun Metal

### Tree Mounting Bracket

**TB** 1/2" NPT

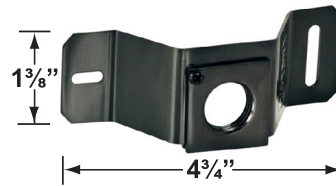

### Surface Canopy

**SC** 5" Surface Canopy, 3-Hole 1/2" NPT

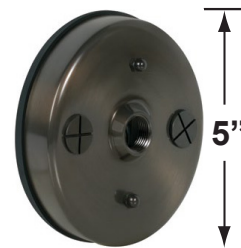

LINE DRAWINGS

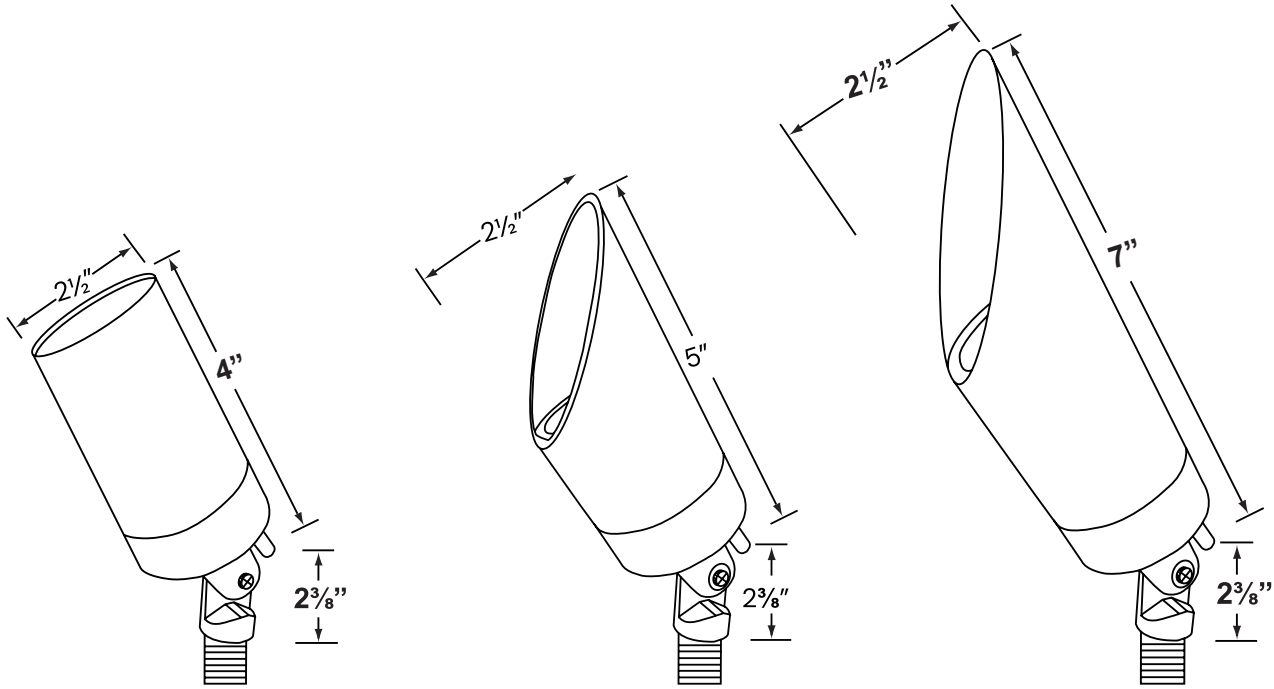

No-Shroud  
9170

Medium Shroud  
9170-MS

Large Shroud  
9170-LS

OPTIONAL REFLECTORS

Included in the package

15°



60°



## SMART ACCESSORIES

### Wireless Bluetooth Mesh Gateway

**WBG** Bluetooth Mesh Technology  
2.4ghz Wi-Fi Wireless Network  
Connects to Tuya Smart app, Alexa, and Google Home for advance app scheduling and automation for a remote lighting control.

Connect up to 128 fixtures per gateway and 4 gateways per app account.

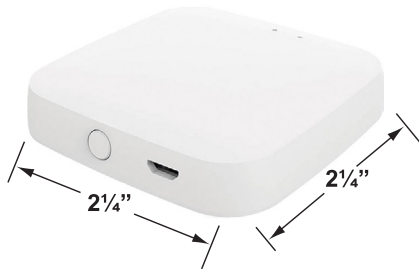

### Bluetooth Range Extender

**BRE** Bluetooth Mesh Technology  
Transmission Range: 260 Feet  
Operating Voltage: 9-17  
IP65 Rating  
Plastic Ground Spike Supplied for Mounting  
Recommended for 10-15 fixtures.

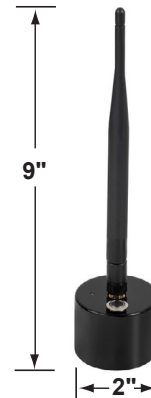

## RGBW-APP | BLUETOOTH SMART PHONE APP



Tuya Smart

Bluetooth	
Software	OS 8.0 and up, Android 4.4 and up
AppS	Smart Life or Tuya Smart supported
Features	Group, Scenes
Bluetooth Distance	> 49ft in open area
Additional Feature	Home Management / Third party control -> Alexa, Google Assistant (by others)

\* For scheduling and automation add Wireless Mesh Gateway (WBG).

### Controls your lighting from your fingerprints

- Change your ambiance to any color.
- Tunable-white color temperatures.
- Sync your lights to your favorite music.
- Create 8 custom scenes with 8 colors.
- Adjustable snap & fade modes.
- Unlimited fixture grouping.
- Control multiple homes.
- Voice assistant options.
- Account based app sharing.

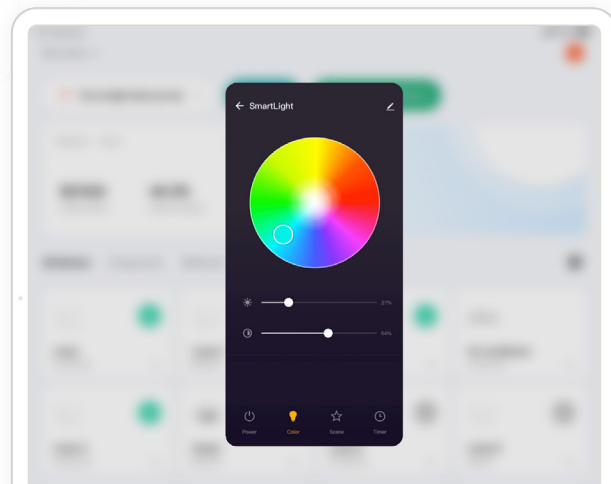

## COLOR TEMPERATURE GUIDE

<p><b>2700K</b></p> <p>WARM WHITE</p> <p>friendly personal intimate</p> <p>HOMES LIBRARIES RESTAURANTS</p> <p>✓</p>	<p><b>3000K</b></p> <p>SOFT WHITE GLOW</p> <p>soft warm pleasing</p> <p>HOMES HOTEL ROOMS LOBBIES RETAIL STORES</p> <p>✓</p>	<p><b>3500K</b></p> <p>NEUTRAL GLOW</p> <p>sociable inviting non-threatening</p> <p>EXECUTIVE OFFICES RECEPTION AREAS SUPERMARKETS</p> <p>✗</p>	<p><b>4000K</b></p> <p>COOL WHITE GLOW</p> <p>neat clean efficient</p> <p>OFFICES CLASSROOMS MASS MERCHANDISERS SHOWROOMS</p> <p>✓</p>	<p><b>5000K</b></p> <p>DAYLIGHT GLOW</p> <p>bright cool alert</p> <p>GRAPHICS INDUSTRY HOSPITALS GALLERIES BEAUTY SALONS</p> <p>✓</p>
---	--	---	--	---