

FIXTURE SPECIFICATIONS

INTENDED USE

Our durable, architectural LED recessed light features a 304 grade stainless steel body with 5mm reinforced glass. IP68 rated for outdoor applications such as pathways, driveways and decks, this 25° beam angle LED light adds value to commercial or residential applications.

FEATURES:

- Construction:** Stainless steel
- Lens:** 5mm reinforced glass
- Input Voltage:** 12V AC/DC
- Dimming:** MLV, ELV, 0-10 and TRIAC
- Wattage:** 3W
- Lumen:** 225 Lumen
- Color Temperature:** 3000K
- Beam Spread:** 25°
- CRI:** 85+
- LED Life:** 50,000 Hrs
- Listings:** cETLus, IP68 Rated for Wet Location
- Warranty:** 5 Years Carefree for Parts & Components (Labor Not Included)

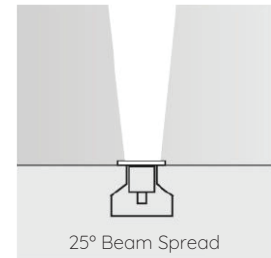
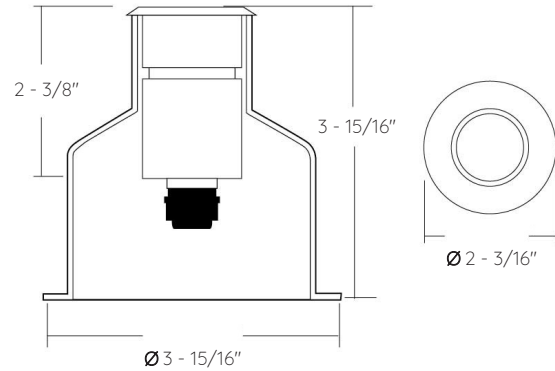

Alcon 9069 Low-Voltage 2-Inch In-Ground LED Well Light



ORDERING INFORMATION EXAMPLE: (9069)

Model

9069

POWER SUPPLY

4N1 SERIES

Compatible with most TRIAC, ELV, MLV & 0-10V Dimmers

4N1-30W-24V

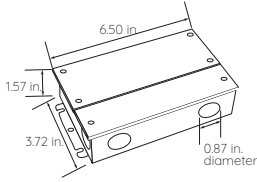

4N1-60W-24V

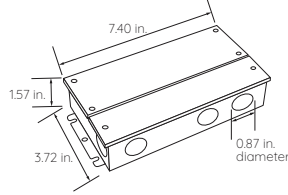

4N1-96W-24V

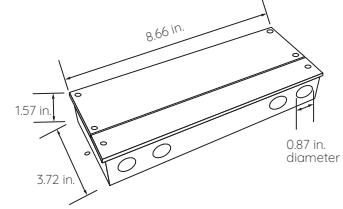

4N1-150W-24V

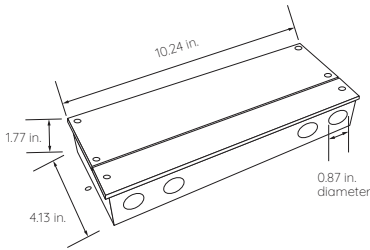

4N1-200W-24V

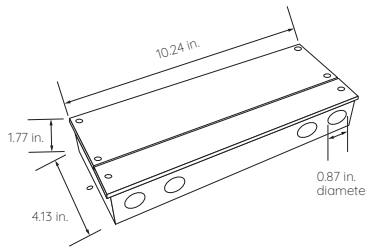

4N1-300W-24V

