

INSTALLATION INSTRUCTIONS

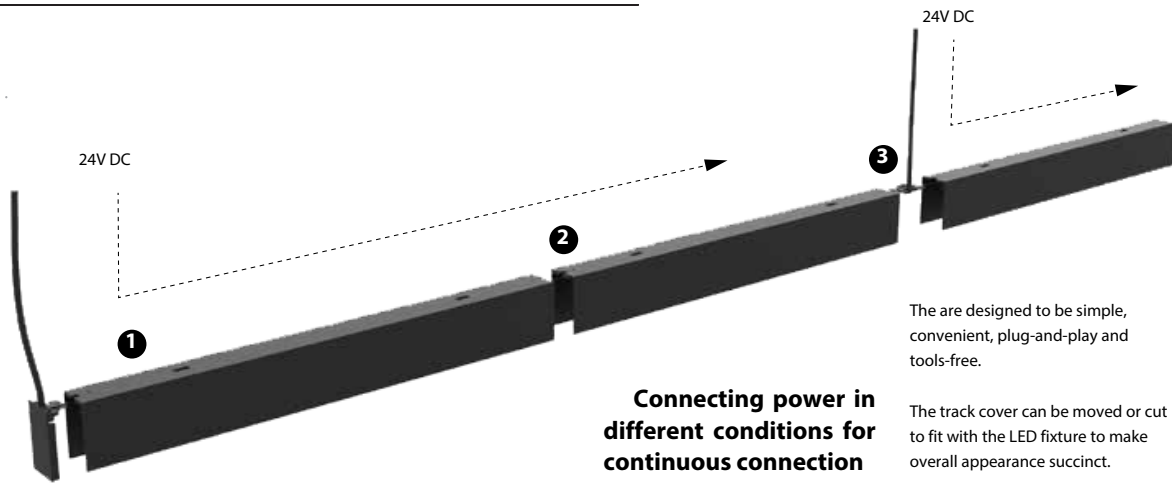

Connecting power in different conditions for continuous connection

The are designed to be simple, convenient, plug-and-play and tools-free.

The track cover can be moved or cut to fit with the LED fixture to make overall appearance succinct.

1 Single Power on a Single Track

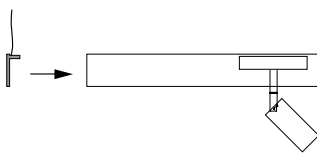
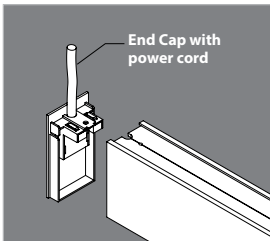

Using power end cap as power feed

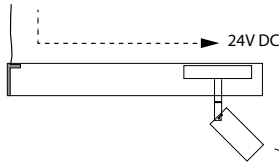

2 Single Power on Multiple Tracks

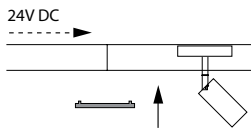
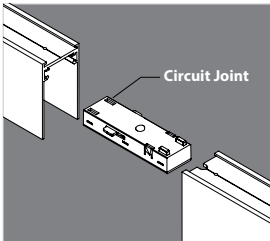

Using circuit joint to connect between tracks

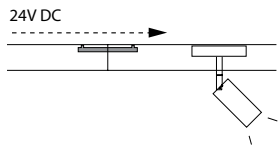

3 Multiple Powers on Multiple Tracks

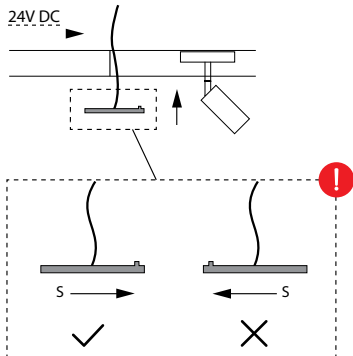
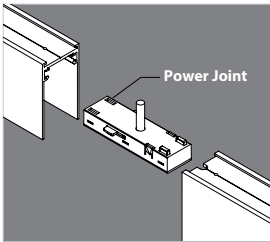

Using power joint to connect more drivers

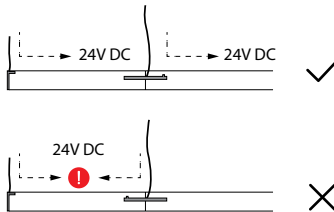

Do not install fixture between the tracks when a new driver is connected into the circuit

INSTALLATION INSTRUCTIONS

Tracks function as continuous linkable units without limitation. It can also divide into sections to light up individual area, making lighting application easy as 123.

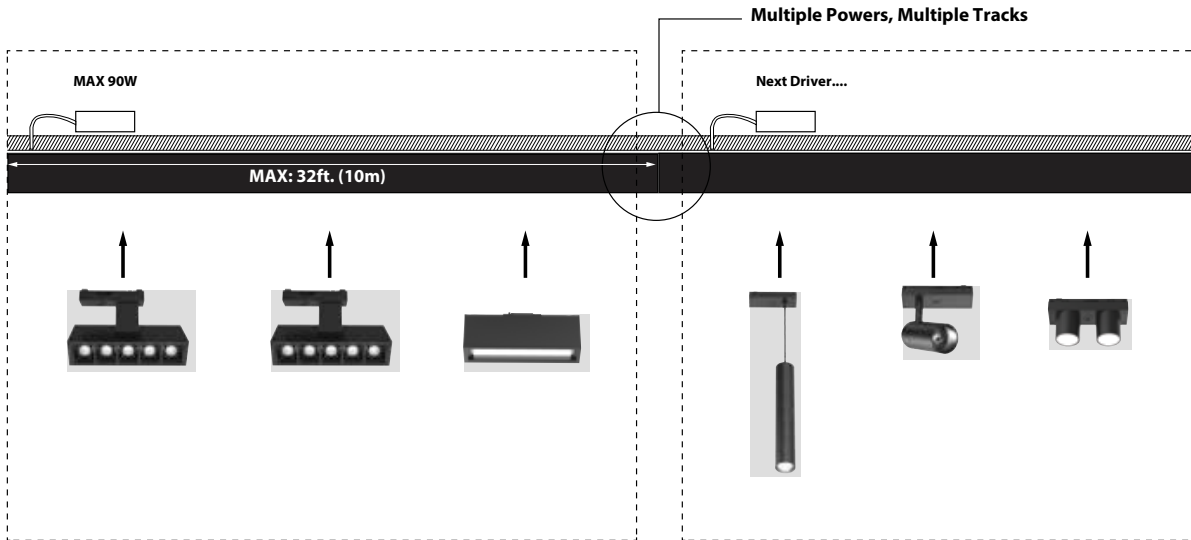
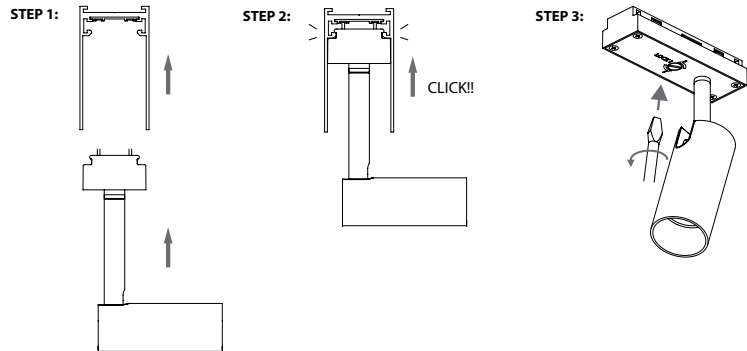

DRIVER INSTALLATION (Remote location)

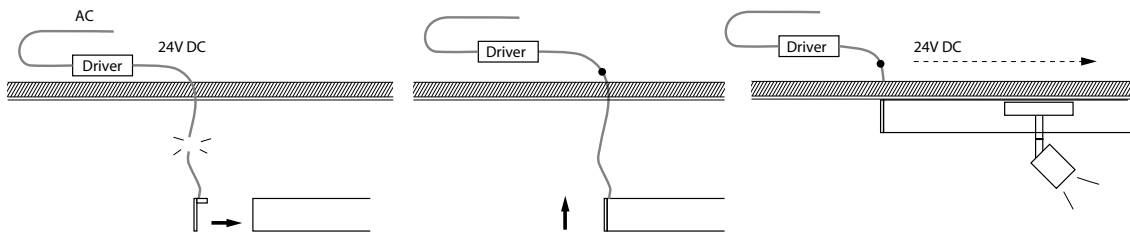

POWER SUPPLY



24V DC 96W driver

INSTALLATION INSTRUCTIONS

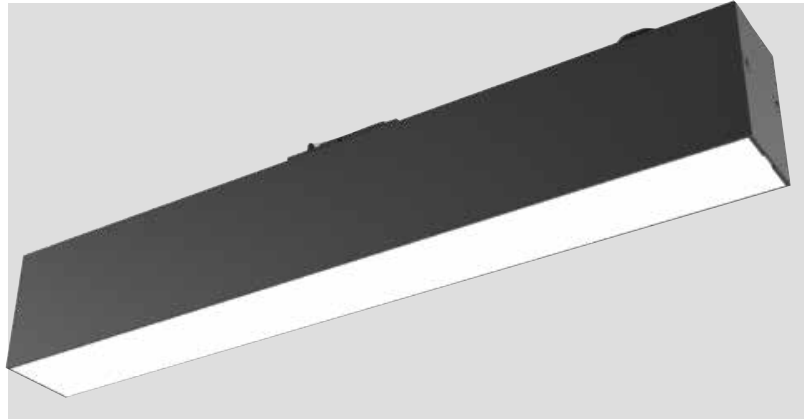

PC cover

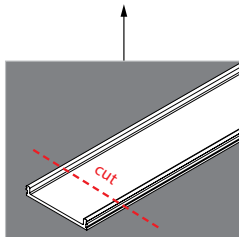

PC cover can be cut into required length

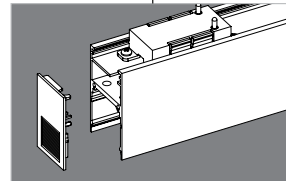

Remove the end cap from the lens module, the modules can be installed next to each other, then use longer PC cover to make seamless appearance.

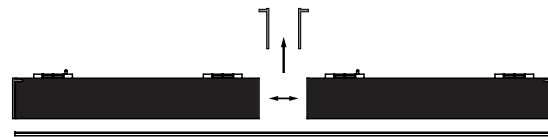
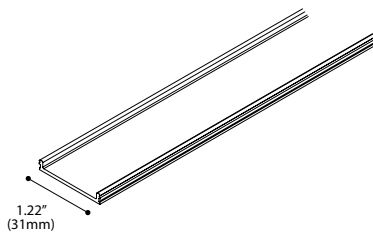

PC COVER - FROSTED LENS

Length	Color
13ft. (4000mm)	Frosted White (-02)
49ft. (15000mm)	Frosted White (-02)