

14030-10-LVR INSTALLATION INSTRUCTIONS

Up 60% faster installation
Over 40% material cost saving

Wire Diagram:

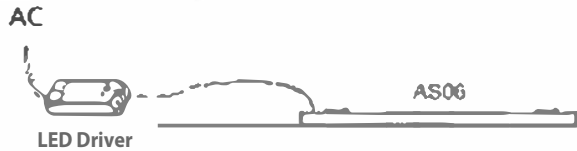

Fixture is compatible with 1/2" to 1" T-Bar Profiles

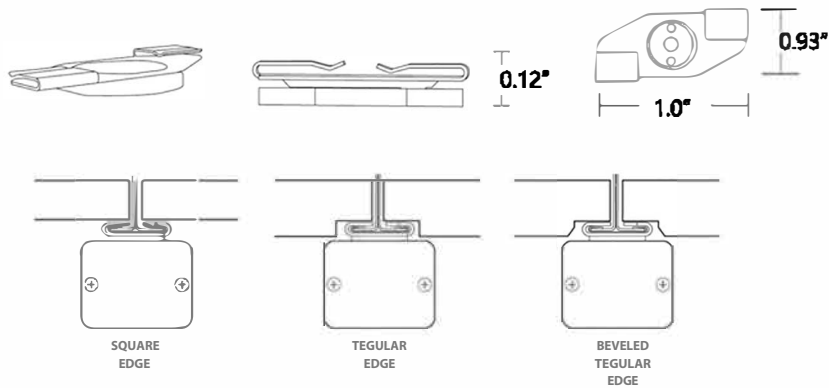

An innovative lighting product solution for T-Grid suspension ceilings

Product Line Drawing:

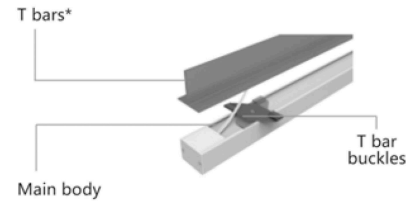

* T bar is not included in the product packaging. The T bar is apart of the ceiling. It is not necessary to modify the T bar to insatall T Grid Lighting System.

Installation steps:

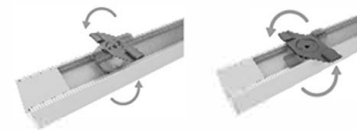

1. Move the hanger toward to the end cap as much as possible and turn the hanger vertically to the light fitting

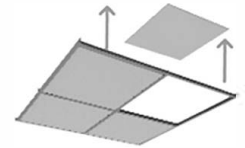

2. Remove the tiles from the T grid for easy installation



3. Place fixture under the T-bar closely



4. Turn the hanger clockwise and lock the hanger to the T bars

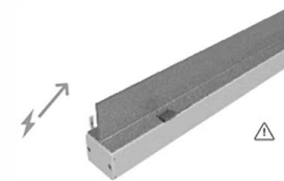

5. Place the Low Voltage cable alongside the T bar and connect to power supply

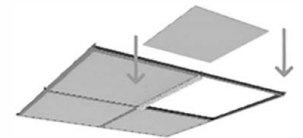

6. Place the tiles back to the ceiling.

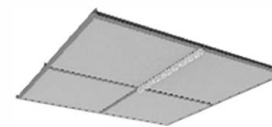

7. Now the Installation is completed