

INSTALLATION INSTRUCTIONS

147W MAX, LED, 120V~, 60Hz
(Dimmable LED Included)

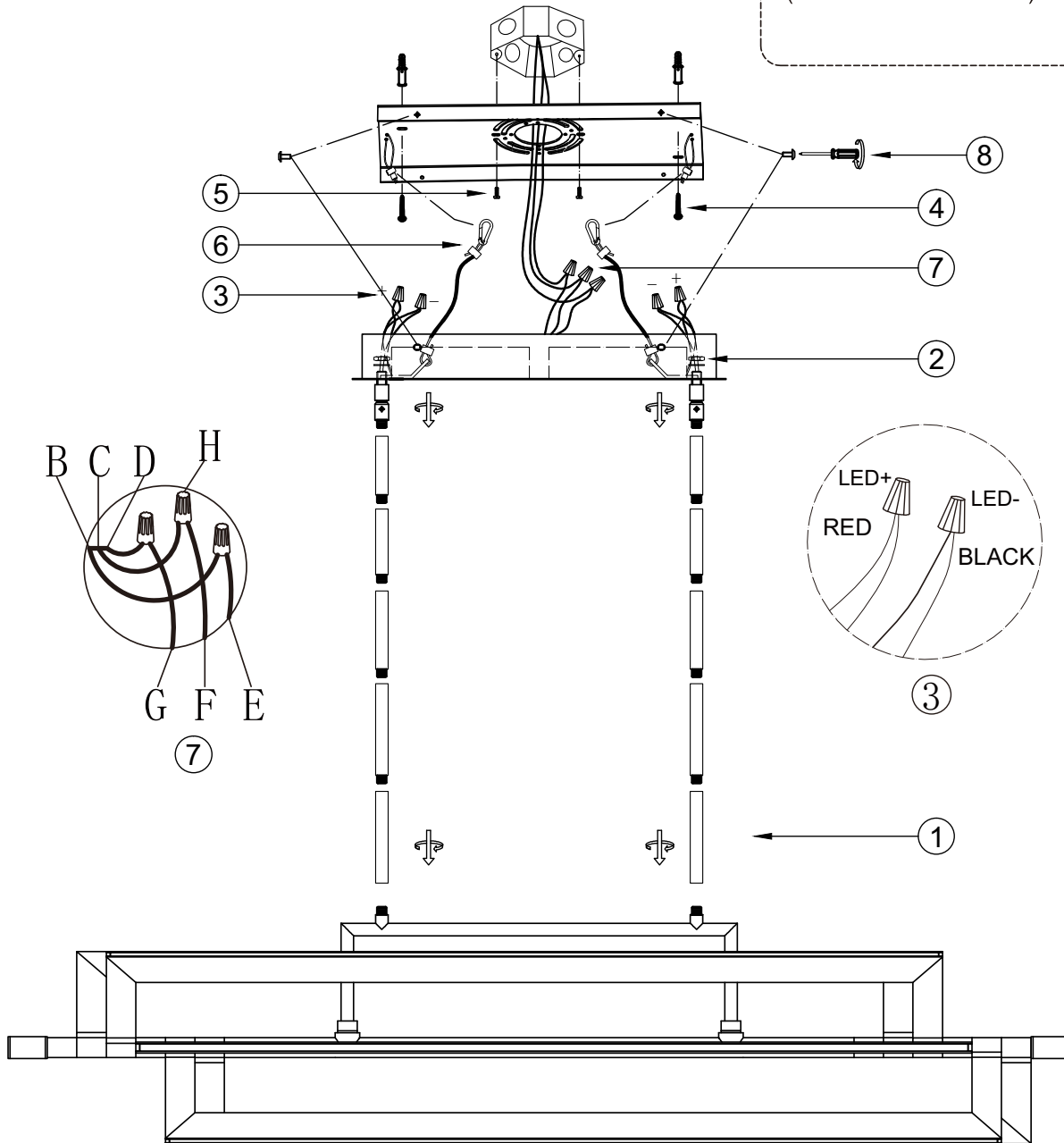

- A-Outlet Box screw x 2
- B-Black wire(L) from junction box
- C-White wire(N) from junction box
- D-Green wire/Bare copper (G) from junction box
- E-Black wire (L) from fixture
- F-White wire (N) from fixture
- G-Green wire/Bare copper from fixture
- H-Wire connector x 3