

Project Name: _____ Type: _____ Quantity: _____

INTENDED USE

Elevate modern commercial interiors with the versatile Surface and Pendant Disk Architectural LED Down Light, designed to combine functionality with contemporary style. Its sleek, low-profile design minimizes glare while delivering high-performance illumination, making it an ideal choice for enhancing the ambiance of lobbies, hotels, retail spaces, and other commercial interiors.

FEATURES

- Construction:** 1-Inch Super Slim Thin Die-Cast Aluminum Frame For Low to Medium Height Ceilings. Integral Heat Sink Design for Maximum Heat Rejection
- Mounting:** for Retrofit, New Construction, and Remodel Applications. Universal Mounting Hardware for All Standard Octagonal Electrical Junction Boxes.
- Lens:** Polycarbonate Frosted White
- Color Temperature:** 30/35/40K Selectable switch
- CRI:** 90+
- Operating Temperature:** Suitable for Temperatures Down to -4°F (-20°C)
- Life:** 50,000 Hours
- Warranty:** 3 years carefree for parts & components (Labor not included)
- Listings:** ETL/CETL Listed, California Title 24/JA8 compliant, Assembled in the USA, Surface mount is Suitable for Wet Location Installations

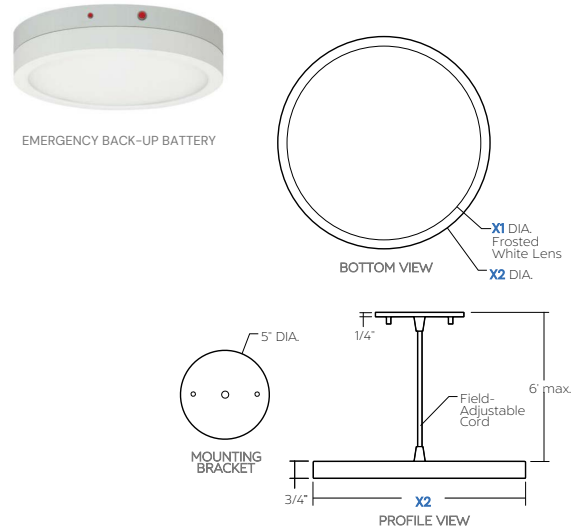

Dimensions				
	12182-5	12182-7	12182-12	12182-18
X1	6.125"	8.125"	11"	16-3/32"
X2	5"	7"	12"	18"

ORDERING INFORMATION Example:

Model	Mounting ¹	Size Watt Lumens	Finish ²	Pendant Mount	Driver	Options
12182	S	5	WH	Blank	ELV	EM14 ^{5,6}
	Surface	5" 11W 1000 Lumens	White	Not required	ELV Dimming 120V	14W Emergency Back-Up Battery
	P	7	BK	6" Stem	010 ^{3,4}	XEM25 ^{5,7}
	Pendant	7" 14W 1400 Lumens	Black	ST12	0-10V Dimming 120/277V	25W Remote Emergency Back-Up Battery
		12	SL	12" Stem		
		12" 22W 2000 Lumens	Silver	ST24		
		18	BZ	24" Stem		
		18" 30W 2000 Lumens	Bronze	ST48		
				48" Stem		

¹ Only surface mount is wet location rated
² For pendant mount the finish applies to Canopy & cord
³ Not Title 24/JA8 compliant
⁴ Requires 4" octagonal junction box with 2-1/8" depth.
⁵ 0-10V Driver Required
⁶ Only for 5" and 7" size
⁷ Only for 12" size

PHOTOMETRY

12182-5-50K (1000lm, 11W, 5000K, CRI 90)

System Power:	11W	MULTIPLIERS	
Test Date:	10/2023	2700K	0.94
Beam Angle 50%:	117.2°	3000K	1.00
Field Angle 10%:	167.1°	3500K	0.99
Color Temperature:	5364K	4000K	0.99
CRI:	94.7	5000K	1.00
Lumens Delivered:	881		
CBCP:	287.9		
Power Factor:	0.92		

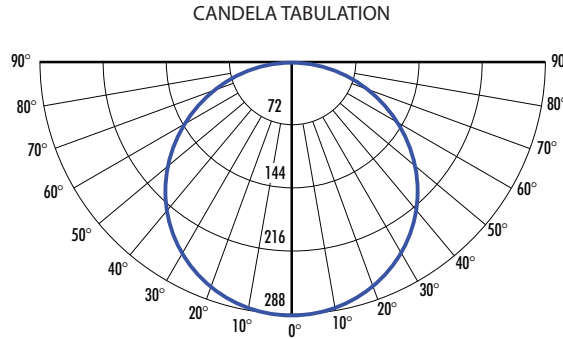

FOOTCANDLE DISTRIBUTION

Height	Beam Diameter	FC
8.0'	26.21'	4.50
9.0'	29.49'	3.55
10.0'	32.77'	2.88
11.0'	36.04'	2.38
12.0'	39.32'	2.00

12182-5-40K (1000lm, 11W, 4000K, CRI 90)

System Power:	11W	MULTIPLIERS	
Test Date:	10/2023	3000K	0.96
Beam Angle 50%:	117.2°	3500K	1.03
Field Angle 10%:	167.2°	5000K	1.00
Color Temperature:	4254K		
CRI:	94.5		
Lumens Delivered:	919		
CBCP:	300		
Power Factor:	0.98		

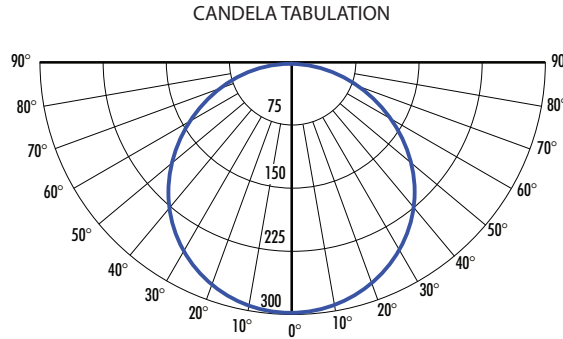

FOOTCANDLE DISTRIBUTION

Height	Beam Diameter	FC
8.0'	26.21'	4.69
9.0'	29.49'	3.70
10.0'	32.77'	3.00
11.0'	36.04'	2.48
12.0'	39.32'	2.08

12182-7-40K (1400lm, 14W, 4000K, CRI 90)

System Power:	15W	MULTIPLIERS	
Test Date:	10/2023	3000K	0.96
Beam Angle 50%:	120.5°	3500K	1.01
Field Angle 10%:	170.4°	4000K	1.00
Color Temperature:	3938K		
CRI:	95.0		
Lumens Delivered:	1132		
CBCP:	354.9		
Power Factor:	0.92		

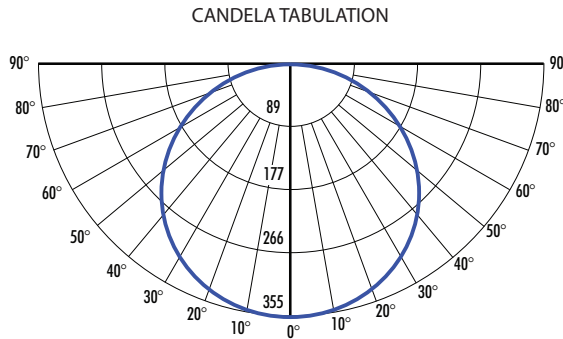

FOOTCANDLE DISTRIBUTION

Height	Beam Diameter	FC
6.0'	20.99'	9.86
8.0'	27.99'	5.54
10.0'	34.99'	3.55
12.0'	41.99'	2.46
14.0'	48.99'	1.81

12182-7-50K (1400lm, 14W, 5000K, CRI 90)

System Power:	14W	MULTIPLIERS	
Test Date:	10/2023	2700K	0.91
Beam Angle 50%:	116.7°	3000K	0.95
Field Angle 10%:	170.5°	3500K	1.00
Color Temperature:	5203K	4000K	1.02
CRI:	93.3	5000K	1.00
Lumens Delivered:	1461		
CBCP:	300		
Power Factor:	0.99		

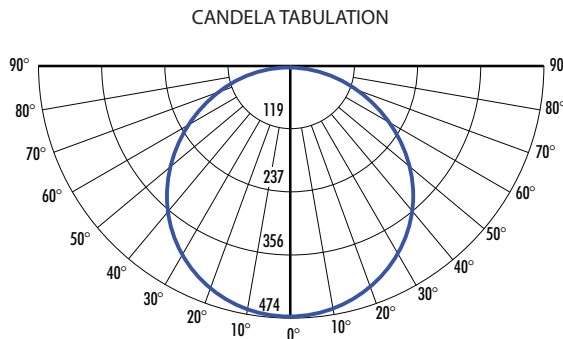

FOOTCANDLE DISTRIBUTION

Height	Beam Diameter	FC
6.0'	19.47'	13.18
8.0'	25.96'	7.41
10.0'	32.45'	4.74
12.0'	38.94'	3.29
14.0'	45.42'	2.42

12182-12-35K (2000lm, 22W, 3000K, CRI 90)

System Power:	22.5W	MULTIPLIERS	
Test Date:	10/2023	4000K	1.07
Beam Angle 50%:	112.7°	3500K	1.04
Field Angle 10%:	164.0°	3000K	1.00
Color Temperature:	3000K	2700K	0.99
CRI:	90		
Lumens Delivered:	1824.25		
CBCP:	633		
Power Factor:	0.99		

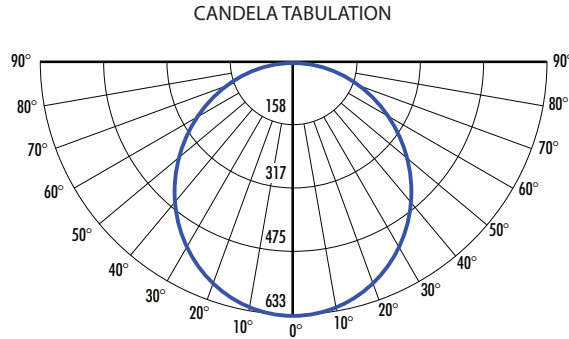

FOOTCANDLE DISTRIBUTION

Height	Beam Diameter	FC
6.0'	18.0'	17.6
8.0'	24.0'	9.9
10.0'	30.0'	6.3
12.0'	36.1'	4.4
14.0'	42.1'	3.2

12182-12-40K (2000lm, 22W, 4000K, CRI 90)

System Power:	22.5W	MULTIPLIERS	
Test Date:	10/2023	4000K	1.00
Beam Angle 50%:	112.6°	3500K	0.97
Field Angle 10%:	164.1°	3000K	0.93
Color Temperature:	4000K	2700K	0.92
CRI:	90		
Lumens Delivered:	1960.3		
CBCP:	680		
Power Factor:	0.99		

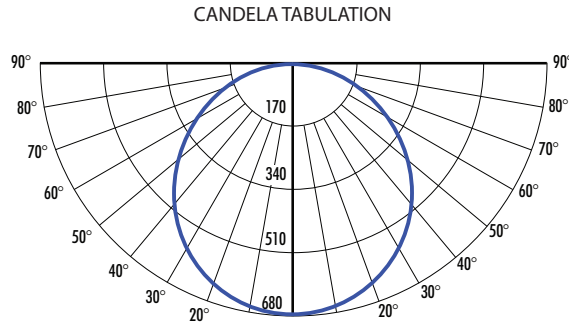

FOOTCANDLE DISTRIBUTION

Height	Beam Diameter	FC
6.0'	18.0'	18.9
8.0'	24.0'	10.6
10.0'	30.0'	6.8
12.0'	36.0'	4.7
14.0'	42.0'	3.5

COLOR TEMPERATURE GUIDE

2700K	3000K	3500K	4000K	5000K
WARM WHITE	SOFT WHITE GLOW	NEUTRAL GLOW	COOL WHITE GLOW	DAYLIGHT GLOW
friendly personal intimate	soft warm pleasing	sociable inviting non-threatening	neat clean efficient	bright cool alert
HOMES LIBRARIES RESTAURANTS	HOMES HOTEL ROOMS LOBBIES RETAIL STORES	EXECUTIVE OFFICES RECEPTION AREAS SUPERMARKETS	OFFICES CLASSROOMS MASS MERCHANDISERS SHOWROOMS	GRAPHICS INDUSTRY HOSPITALS GALLERIES BEAUTY SALONS
✓	✓	✓	✓	✓