



BEFORE YOU BEGIN
Read and follow all safety instructions



WARNING

RISK OF FIRE, EXPLOSION AND ELECTRIC SHOCK

- This product should be installed, inspected, and maintained by a qualified electrician only, in accordance with the NEC (National Electric Code) and all local codes.
- Turn off electrical power before inspection, installation or removal.
- Use only UL (or other NTRL) approved wire for input/output connections.
- Make sure LEDs and drivers are cool to touch when performing maintenance.
Make sure the supply voltage is the same as the rated voltage of the luminaire.
- Do not install in a hazardous atmosphere, except where the ambient temperature does not exceed the rated operating temperature of the fixture.
- Keep tightly closed when in operation



Prepare Electrical Wiring



Electrical Requirements

Must check if the local voltage range is correspond with the working voltage of the fixture. Use min. 75°C supply.



Grounding Instructions

The grounding and bonding of the overall system shall be done in accordance with NEC Article 600 and local codes.



Follow all applicable safety procedures and use Personal Protective Equipment such as hardhats, safety glasses, reflective vest, electrical safety gloves, fall protection equipment and safety toe boots during the installation, operation, and maintenance of the luminaire.

INSTALLATION INSTRUCTIONS

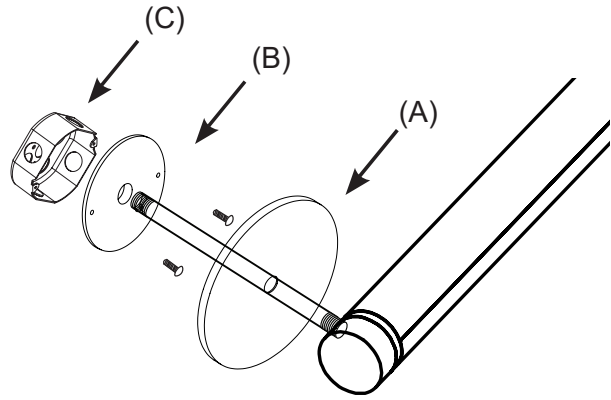

- (A): Cover Plate (provided)
 - (B): Mounting Plate (provided), screws by others.
 - (C): Junction Box (by others).
- A set of stem is provided.

Dimensions

All dimensions are in inches (millimeters).

(A) Cover Plate

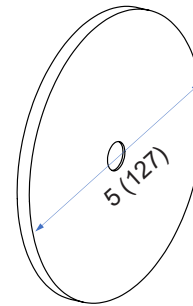

(B) Mounting Plate

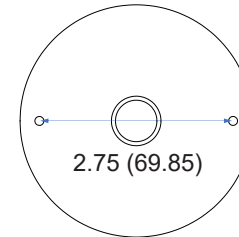

Stem

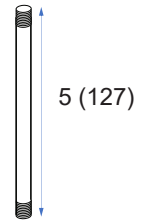

Allen key is provided per fixture.

INSTALLATION INSTRUCTIONS

Individual Installation

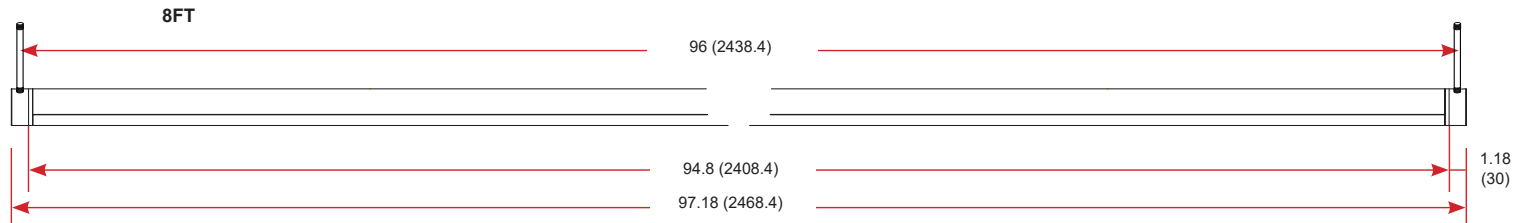
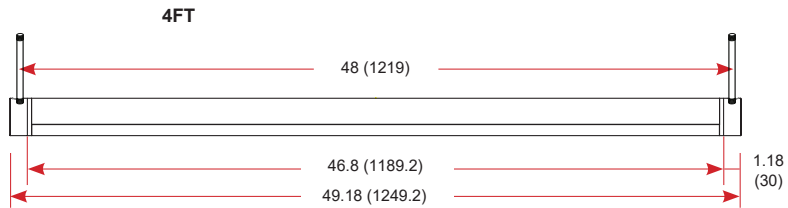
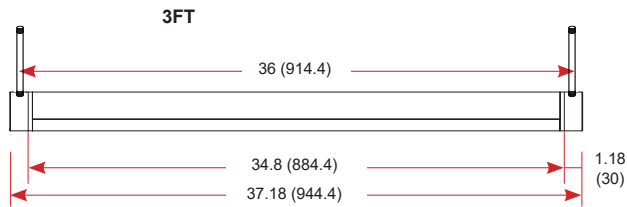
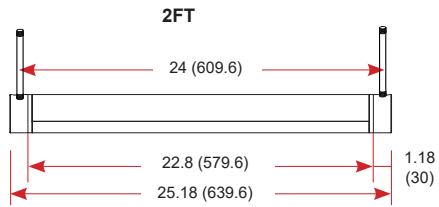

Continuous Run Installation

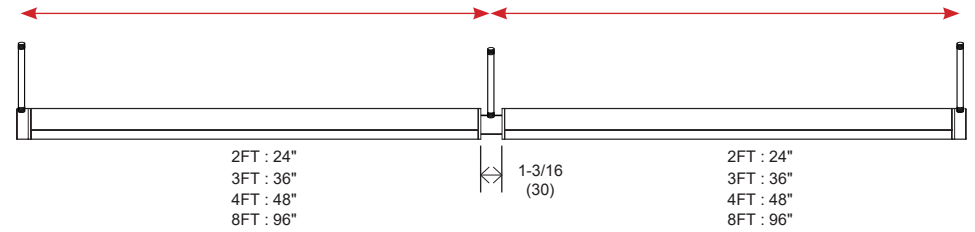

All dimensions are in inches (millimeters).

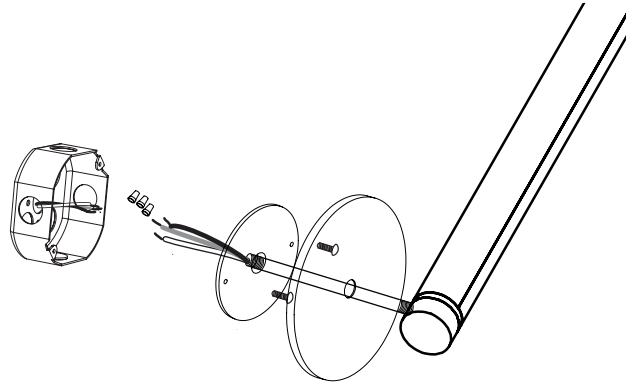

Complete Look with 90° angle

1. Install J-Box (by others) on the wall and secure the mounting plate.
*Please follow the mounting distance provided on the previous page.
2. Remove both end caps from the fixture with the Allen key provided (one set screw per end cap).
3. Slide cover plate over stem, run wires from the fixture out through the end cap, inside the stem and out to J-Box. Twist and lock stem on both mounting plate and end cap.
4. Make sure the stem installed on the end cap is tightly secured.
5. Complete wire make-up per code to J-Box.
6. Slide cover plate over mounting plate (magnets will pull cover plate tight against and flush to the wall).
7. Reinstall the housing to both end caps.

IMPORTANT: To level the fixture, adjust the stem attached on the mounting plate. **DO NOT** adjust the stem installed on the end cap. Stem must be tightly secured on the end cap.

INSTALLATION INSTRUCTIONS

Continuous Run Instructions

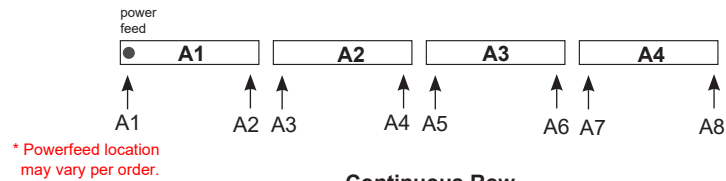

Continuous Row

Align continuous row fixtures in numerical order under the same alphabet family.

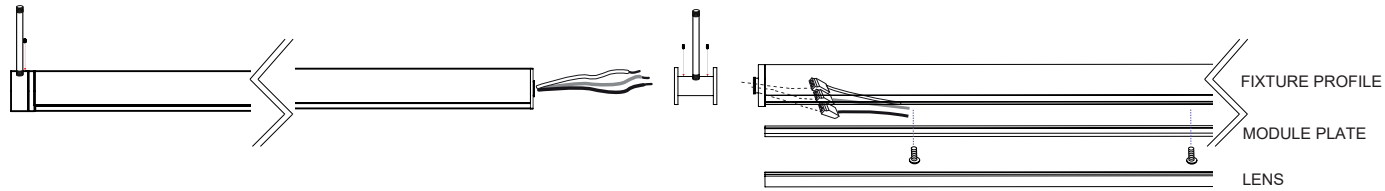

1. Follow the mounting instructions on the previous page.
2. Once all continuous run fixtures are installed on the wall, open and remove lens and module plate.
3. Connect Male and Female Wago connectors inside the next running fixture, under the module plate.
4. Reinstall module plate and lens to complete the installation.

INSTALLATION INSTRUCTIONS

Field Adjustable Angle Instructions

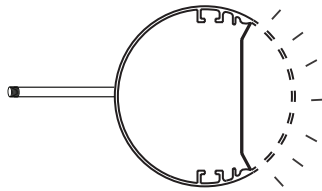

Standard

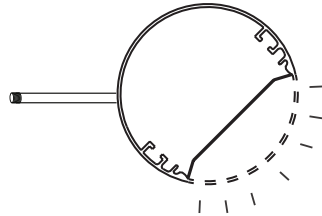

45°

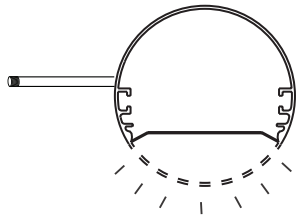

90°

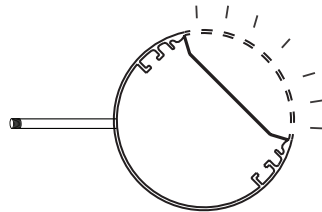

135°

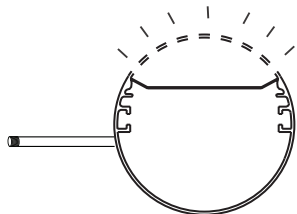

180° (Up)



1. Use the Allen key provided to loosen the end cap / coupling / shaped joiner.
2. Look for laser print angle marks on the end of the fixture and rotate to your preferred angle.
3. Fix the end cap / coupling / shaped joiner.

INSTALLATION INSTRUCTIONS

Emergency Battery Backup Wire Connection

3. Unit(s) with Emergency Battery Backup:

- It is important to open fixture to connect the converter connector and give a full 24 hours charge prior to operation.

