

FIXTURE SPECIFICATIONS

INTENDED USE

The specification grade **Continuum 40 Architectural Linear LED Suspension Lighting** delivers continuous clean lines and clear light to commercial, hospitality and residential interior lighting applications. Our modern, slim profiles and stylish designs offer excellent illumination, exceptional performance and versatility in offices, classrooms, conference rooms, museums, retail outlets, hotels, restaurants, and more.

PRODUCT FAMILY

- 12100-40-P-U U Shape
- 12100-40-P-T T Shape

AVAILABLE LENGTHS

- 2FT, 3FT, 4FT, 6FT & 8FT
- Continuous Run | Consult Factory
- Custom Length | Consult Factory

FEATURES

- Construction:** Die-Formed and welded 22-gauge cold rolled steel, painted finish with premium paint
- Continuous Run:** Full ability to tandem mount for continuous run application
- Indirect Mounting:** For Most Effective Indirect Lighting Result, Mount at No Less Than 18" from the Ceiling
- Custom Design:** Offered with Pre-Fabricated and Fully Illuminated Corners
- Lens:** Glare Free Snap In Frosted Acrylic for Even Distribution
- Voltage:** 50/60 Hz Constant Current 0-10V @ 120-277V, TRIAC & ELV @ 120V
- Dimming:** 0-10V, TRIAC (Forward-Phase), ELV (Reverse-Phase)
- Controls:** Lutron Vive, Lutron Ecosystem, Philips EasySense, Siemens Enlightend
- CRI:** 80+ & 90+
- Life:** +60,000 Reported L70 Hours @ 55°C
- Operating Temperature:** 4°F (-20°C) ~ 122°F (50°C).
- Warranty:** 5 Years Carefree for Parts & Components (Labor Not Included)
- Listings:** UL / CUL listed, DLC listed, ADA compliant,



ORDERING INFORMATION Example: (12100-40-P-D18-L-26+26-27K-010-WH-A)

Model	Mounting	LED Downlight	LED Uplight ¹	Shape		Color Temp	Dimming	Finish	Pendant Mounting	CRI	Options	Optional Controls
12100-40 4" x 4"	P Pendant	Per 4 Foot Sections		L L Shape		Residential 27K 2700K 30K 3000K Commercial 35K 3500K 40K 4000K Industrial 50K 5000K Tunable White TW Tunable White 2700-5000K	010 0-10V 5-Wire TRI TRIAC Forward Phase 2-Wire ELV Electronic Low Voltage Reverse Phase 3-Wire DL DALI	WH White (Matte) RAL# 9003 BK Black (Matte) RAL# 9011 SL Silver (Matte) RAL# 9022 XXXX Specify XXXX: Use RAL # found on Page 2	(Blank) None Required AC4 4' Adjustable Aircraft Cable AC8 8' Adjustable Aircraft Cable ACX Specify X in Feet (Max 30')	8 80+ CRI 9 90+ CRI	Blank No Options EM5 5W Emergency Ballast EM8 8W Emergency Ballast EM16 16W Emergency Ballast OS Occupancy Sensor w/ Daylight Harvesting DS Daylight Dimming Photo Sensor AB Separate Dimming Control of Uplight and Downlight	Blank No Controls LV Lutron VIVE™ Wireless LE Lutron Ecosystem™ PH Philips EasySense™ EN Siemens Enlightened™
		S Surface	D18 18 Watts 2661 Lumens									
	D27 27 Watts 3302 Lumens		U18 18 Watts 2661 Lumens									
	D36 36 Watts 4560 Lumens		U27 27 Watts 3302 Lumens									
	D48 48 Watts 5486 Lumens											
D54 54 Watts 6459 Lumens												

¹ Length Minimum 26"
² Length Minimum 26"

Available Finishes

Standard

	01	White	RAL #9003
	02	Black	RAL #9011
	03	Silver	RAL #9022
	04	Crystal White	RAL #9010
	05	Natural Aluminum	RAL #7035
	06	Hampden	RAL #9001
	07	London	RAL #7044

Metropolitan

	08	Urban Native	RAL #8025
	09	Military Green	RAL #6011
	10	Carmin	RAL #8028
	11	Chocolate Spice	RAL #8017
	12	Asher Grey	RAL #7004
	13	Tech Grey	RAL #7016
	14	Slate	RAL #7031
	15	Mason	RAL #7039

Vibrant

	16	Violet Dreams	RAL #4006
	17	Sangria Sunset	RAL #2004
	18	Deep Pink	RAL #4010
	19	Ruby Red	RAL #3027
	20	Island Skye	RAL #6027
	21	Sophia	RAL #5015
	22	Antique Spring	RAL #6019
	23	Daisy	RAL #1018
	24	Gun Metal	RAL #7024

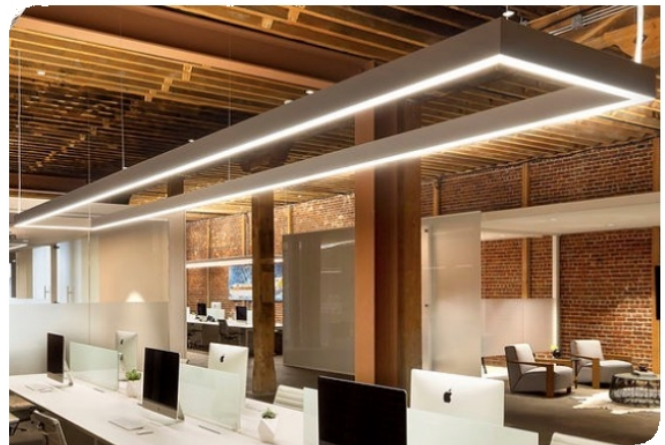
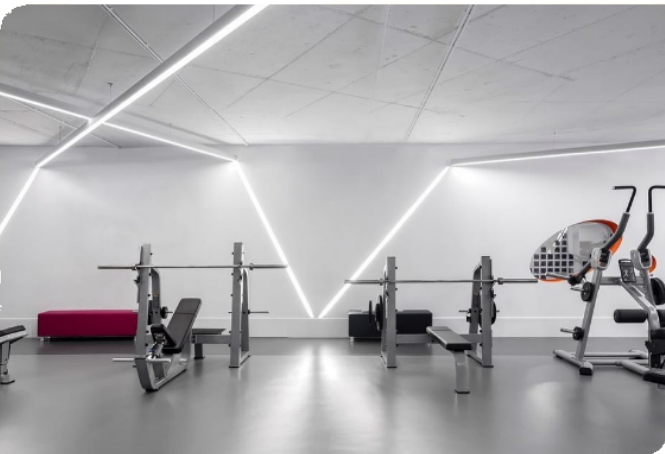

6VFS[e

Drywall

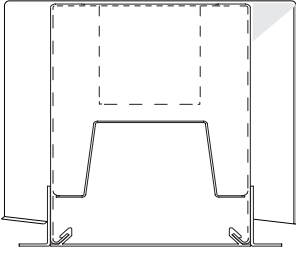

Flange Detail

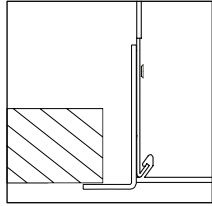

Cable Pendant

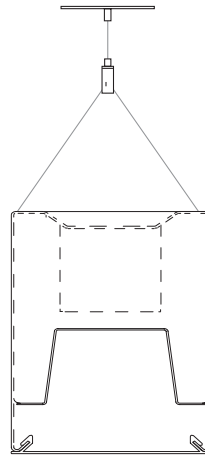

Stem Pendant

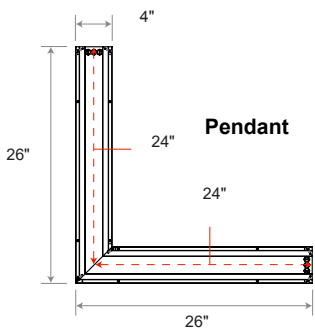
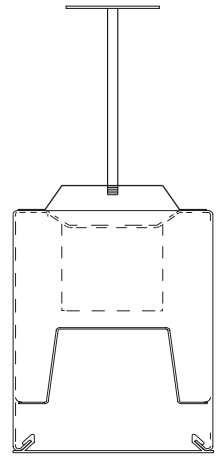

Pendant

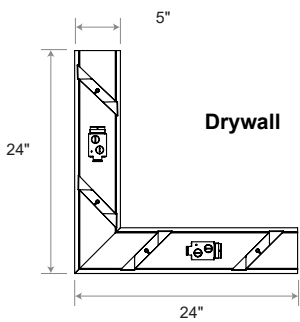
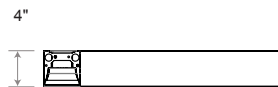

Drywall

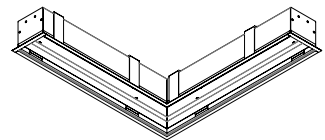
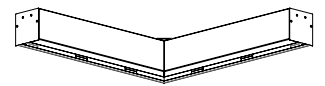
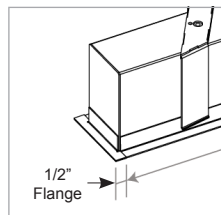
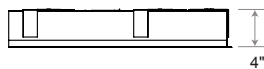

Controls

Smart Sensors	Protocol	Compatible Networks	Occupancy	Daylight	Temperature Reporting	Communication to Luminaire
enlighted	Enlighted RF	Enlighted RF	Integrated	Integrated	Yes	Wireless
LUTRON	EcoSystem	Quantum, Energi Savr Node, Energi TriPak	Enabled	Enabled	No	Wired
VIVE	Lutron Clear Connect*	Lutron Vive System Network	Enabled	Enabled	No	Wireless
PHILIPS	ZigBee HA	Philips	Enabled	Enabled	No	Wired

Controls Installed on the Fixture

FCJS-010
Individual
Fixture Control

Fixture Will be Shipped LUTRON VIVE Enabled with LUTRON FCJS-010 0-10V Control Module Installed on the Fixture. Fixtures will be compatible with Lutron FC-SENSOR Occupancy/Daylight Sensor or FC-VSENSOR Vacancy/Daylight Sensor which can be Added in the Field for Remote Mounting. Fixture May be Controlled with any Vive control systems. Fixtures must be ordered with a 0-10V. Driver.

FCJS-ECO
Individual
Fixture Control

Fixture Will be Shipped LUTRON VIVE Enabled with LUTRON FCJS-ECO EcoSystem Control Module Control Module Installed on the Fixture. Fixtures will be compatible with Lutron FC-SENSOR Occupancy/Daylight Sensor or FC-VSENSOR Vacancy/Daylight Sensor which can be Added in the Field for Remote Mounting. Fixture May be Controlled with any Vive control systems. Fixtures must be ordered with a Lutron Driver.

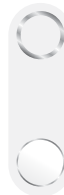
DFCSJ-OEM-OCC

Fixture Will be Shipped LUTRON VIVE Enabled with DFCSJ-OEM-OCC* Vive Integral Fixture Control (with Sensing) Installed on the Fixture. Fixture May be Controlled with any Vive control systems. Fixtures must be ordered with a DMX or Lutron EcoSystem Driver

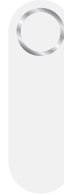
DFCSJ-OEM-RF

Fixture Will be Shipped LUTRON VIVE Enabled with LUTRON DFCSJ-OEM-RF* Vive Integral Fixture Control (RF Only) Installed on the Fixture. Fixture May be Controlled with any Vive control systems. Fixtures must be ordered with a DMX or Lutron EcoSystem Driver.

Controls Provided by Lutron

Vive Wireless Hub



 DayLight
Sensor

 Ceiling Mount
Occupancy/Daylight
Sensor

 Ceiling Mount
Occupancy Sensor

 Pico
Remote

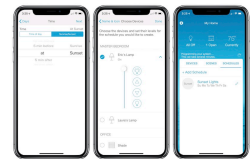
 Wall Mount
Switch

 Wall Mount
Occupancy Sensor

Lutron App

Controls



Fixture will be shipped with Leviton ZL027-N0W power control module installed on the fixture. Fixtures will be compatible with Leviton ZL00J-D0W sensor control module which can be added in the field for remote mounting. Fixture must be controlled with Leviton Intellect Keypad Room Controller, or Leviton Neuron App.



ZL027-N0W
Power control module



ZL00J-D0W
Sensor control module

Leviton Keypad



ZLDNK-1W



ZLDNK-2W



ZLDNK-4W



ZLDNK-8W

Intellect™ Keypad Room Controller (Required)

Leviton App



Neuron App



Philips EasySense sensors provide luminaire-level control with Occupancy sensing, Daylight harvesting, and Field task tuning.

Controls Installed on the Fixture



PHILIPS-XSR + SNS200

Fixture will be Shipped with EasySense SNS200 Sensor installed and PHILIPS-XSR driver. Fixture May Only be Controlled with Philips Field App or Wireless Switches.



SRB + SNS200

Fixture Will be Shipped with EasySense SNS200 Sensor installed and PHILIPS SRB Bridge. Fixture May Only be Controlled with Philips Field App or Wireless Switches or any 0-10V. Wall Box Dimmer.



Controls Provided by Philips



ZBT-S1AWH



ZBT-S2AWH

Ilumra Wireless Switches



PHILIPS-XSR + SNS200-CMP

Fixture will be Shipped Sensor Ready with PHILIPS-XSR driver and EasySense SNS200-CMP Sensor which is Included to be Remote Mounted. Fixture May Only be Controlled with Philips Field App or Wireless Switches

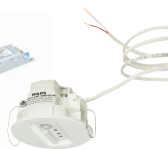

SRB + SNS200-CMP

Fixture Will be Shipped Sensor Ready with PHILIPS SRB Bridge and EasySense SNS200-CMP Sensor which is Included to be Remote Mounted. Fixture May Only be Controlled with Philips Field App or Wireless Switches or any 0-10V. Wall Box Dimmer.





SRB

Fixture will be Shipped Sensor Ready with SRB Bridge. Fixture will be Compatible with EasySense Sensor SNS200-CMP which can be Added in the Field for Remote Mounting. Fixture May Only be Controlled with Philips Field App or Wireless Switches or any 0-10V. Wall Box Dimmer.



Philips Field App

Compatible Dimmers

MFG	Triac	ELV	0-10
	TG-600P LG-600P TGCL-153P DV-600P DVCL-153P S-603PG CT-103P S-600P	DVELV-303P SELV-300P MAELV-600 FAELV-500	NTSTV NFTV DVSTV
		6161 6633-P 6683 6631-2 IPI06-1LZ	IPE04 VPE06-1LZ IP710-DLZ

COLOR TEMPERATURE GUIDE



2700K	3000K	3500K	4000K	5000K
WARM WHITE	SOFT WHITE GLOW	NEUTRAL GLOW	DAYLIGHT GLOW	CRYSTAL WHITE GLOW
friendly personal intimate	soft warm pleasing	sociable inviting non-threatening	neat clean efficient	bright cool alert
HOMES LIBRARIES RESTAURANTS	HOMES HOTEL ROOMS LOBBIES RETAIL STORES	EXECUTIVE OFFICES RECEPTION AREAS SUPERMARKETS	OFFICES CLASSROOMS MASS MERCHANDISERS SHOWROOMS	GRAPHICS INDUSTRY HOSPITALS GALLERIES BEAUTY SALONS

Photometrics

Direct

12100-40-D27-S-4

Illuminance at a Distance

	Center Beam FC	Beam Width
1.7FT	555 FC	3.9 FT 3.1 FT
3.3FT	147 FC	7.6 FT 6.1 FT
5.0FT	64.1 FC	11.6 FT 9.2 FT
6.7FT	35.7 FC	15.5 FT 12.3 FT
8.3FT	23.3 FC	19.2 FT 15.2 FT
10.0FT	16.0 FC	23.2 FT 18.4 FT

- Vert. Spread: 98.4°
- Horiz. Spread: 85.1°

12100-40-D27-S-8

Illuminance at a Distance

	Center Beam FC	Beam Width
1.7FT	1,117 FC	3.9 FT 3.1 FT
3.3FT	296 FC	7.6 FT 6.1 FT
5.0FT	129 FC	11.6 FT 9.2 FT
6.7FT	71.9 FC	15.5 FT 12.3 FT
8.3FT	46.8 FC	19.2 FT 15.2 FT
10.0FT	32.3 FC	23.2 FT 18.4 FT

- Vert. Spread: 98.4°
- Horiz. Spread: 85.1°

Direct/Indirect

12100-40-D27-U27-S-4

Illuminance at a Distance

	Center Beam FC	Beam Width
1.7FT	470 FC	3.9 FT 3.3 FT
3.3FT	296 FC	7.6 FT 6.5 FT
5.0FT	129 FC	11.5 FT 9.8 FT
6.7FT	71.9 FC	15.5 FT 13.2 FT
8.3FT	46.8 FC	19.1 FT 16.3 FT
10.0FT	32.3 FC	23.1 FT 19.7 FT

- Vert. Spread: 98.1°
- Horiz. Spread: 89.0°

12100-40-D27-U27-S-8

Illuminance at a Distance

	Center Beam FC	Beam Width
1.7FT	940 FC	3.9 FT 3.3 FT
3.3FT	249 FC	7.6 FT 6.5 FT
5.0FT	109 FC	11.5 FT 9.8 FT
6.7FT	60.5 FC	15.5 FT 13.2 FT
8.3FT	39.4 FC	19.1 FT 16.3 FT
10.0FT	27.2 FC	23.1 FT 19.7 FT

- Vert. Spread: 98.1°
- Horiz. Spread: 89.0°

12100-40-D54-S-4

Illuminance at a Distance

	Center Beam FC	Beam Width
1.7FT	993 FC	3.9 FT 3.1 FT
3.3FT	263 FC	7.6 FT 6.1 FT
5.0FT	115 FC	11.6 FT 9.2 FT
6.7FT	63.9 FC	15.5 FT 12.3 FT
8.3FT	41.6 FC	19.2 FT 15.2 FT
10.0FT	28.7 FC	23.2 FT 18.4 FT

- Vert. Spread: 98.4°
- Horiz. Spread: 85.1°

12100-40-D54-S-8

Illuminance at a Distance

	Center Beam FC	Beam Width
1.7FT	1,986 FC	3.9 FT 3.1 FT
3.3FT	527 FC	7.6 FT 6.1 FT
5.0FT	230 FC	11.6 FT 9.2 FT
6.7FT	128 FC	15.5 FT 12.3 FT
8.3FT	83.3 FC	19.2 FT 15.2 FT
10.0FT	54.7 FC	23.2 FT 18.4 FT

- Vert. Spread: 98.4°
- Horiz. Spread: 85.1°

12100-40-D54-U18-S-4

Illuminance at a Distance

	Center Beam FC	Beam Width
1.7FT	982 FC	3.8 FT 3.1 FT
3.3FT	261 FC	7.4 FT 5.9 FT
5.0FT	114 FC	11.3 FT 9.0 FT
6.7FT	63.2 FC	15.1 FT 12.1 FT
8.3FT	41.2 FC	18.7 FT 14.9 FT
10.0FT	28.4 FC	22.6 FT 18.0 FT

- Vert. Spread: 96.9°
- Horiz. Spread: 83.9°

12100-40-D54-U18-S-8

Illuminance at a Distance

	Center Beam FC	Beam Width
1.7FT	1,965 FC	3.8 FT 3.1 FT
3.3FT	521 FC	7.4 FT 5.9 FT
5.0FT	227 FC	11.3 FT 9.0 FT
6.7FT	126 FC	15.1 FT 12.1 FT
8.3FT	82.4 FC	18.7 FT 14.9 FT
10.0FT	56.8 FC	22.6 FT 18.0 FT

- Vert. Spread: 96.9°
- Horiz. Spread: 83.9°

Pendant Installation

A simple design and adjustable components provide a flexible and hassle-free experience when installing the Continuum Series™.

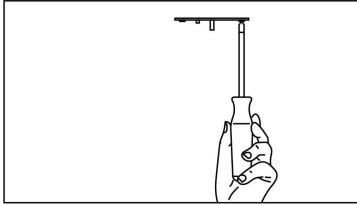

Step 1: Secure cross brackets to junction boxes for both power and non power mounting points.

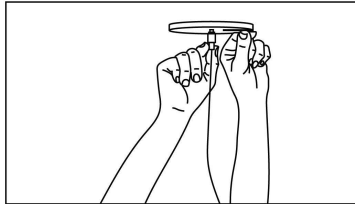

Step 2: Secure canopy with power canopy coupler (Power Feed Mount) & secure canopy with cable terminal (Non Power Feed Mount).

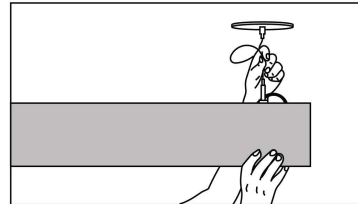

Step 3: Feed aircraft cable into cable grippers, adjust height and level luminaire.

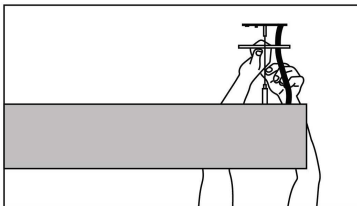

Step 4: Unscrew outer coupler to allow access to junction box. Feed power cord through canopy.

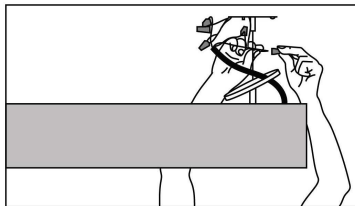

Step 5: Secure canopy back in place with outer coupler.

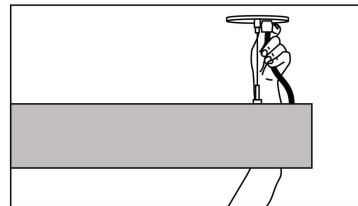

Step 6: Snap strain relief around power cord. Press into canopy.