



11182 INSTALLATION INSTRUCTIONS WITH OPTIONAL BACK-UP BATTERY FOR ARCHITECTURAL ROUND SURFACE-MOUNTED LED LIGHT

Safety Precautions:

- This product should be installed, inspected, and maintained by a qualified electrician only, in accordance with the NEC (National Electric Code) and all local codes.
- Turn off electrical power before inspection, installation or removal. Do not handle any energized fixture or attempt to energize any fixture with wet hands or while standing on a wet or damp surface or in water.
- This fixture is designed for use in a 120–277VAC / 60Hz circuit. This fixture is compatible with a TRIAC (forward-phase or leading-edge) / ELV (reverse-phase or trailing-edge) and 0–10V dimmer.
- Make sure that the power source conforms to the requirements of the fixture. (See labels on the fixture housing).
- To reduce the risk of electrical shock, and to assure proper operation, this fixture must be adequately grounded. To accomplish proper grounding, there must be a separate ground wire (green) contact between this fixture and the ground connection of your main power supply panel.

Disclaimer:

Changes or modifications not expressly approved by the party responsible for compliance could void the user's authority to operate the equipment.

NOTE:

This equipment has been tested and found to comply with the limits for a Class B digital device, pursuant to Part 15 of the FCC Rules and Canadian ICES–005 (B) / NMB–005 (B). These limits are designed to provide reasonable protection against harmful interference in a residential installation. This equipment generates, uses, and can radiate radio frequency energy and, if not installed and used in accordance with the instructions, may cause harmful interference to radio communications. However, there is no guarantee that interference will not occur in a particular installation. If this equipment does cause harmful interference to radio or television reception, which can be determined by turning the equipment off and on, the user is encouraged to try to correct the interference by one or more of the following measures:

- Reorient or relocate the receiver antenna.
- Increase the separation between the equipment and receiver.
- Connect the equipment into an outlet on a circuit different from that to which the receiver is connected.
- Consult with the dealer or an experienced radio/TV technician for help.

Any modifications to this fixture may void the warranty and interfere with the safe operation of the luminaire.

Operation is subject to the following two conditions: (1) this device may not cause interference, and (2) this device must accept any interference, including interference that may cause undesired operation of the device.

11182 INSTALLATION INSTRUCTIONS WITH OPTIONAL BACK-UP BATTERY FOR ARCHITECTURAL ROUND SURFACE-MOUNTED LED LIGHT

Step 1 – Preparing for installation

Disconnect electrical power at fuse or circuit breaker box before installing or servicing any part of this fixture and carefully remove the fixture from the carton, remove components from hardware kit.

A

Remove diffuser (2) from fixture (1) by gently pushing one side up inside top corner and pulling the other side out from the fixture then set it aside until ready to be reinstalled.

B

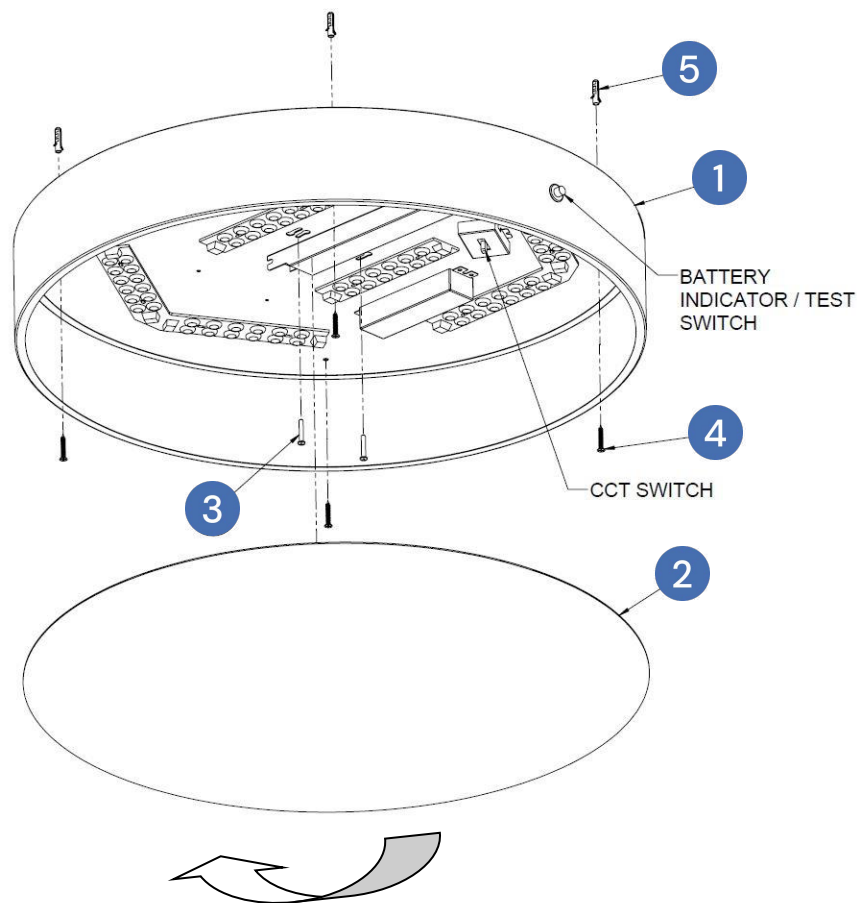

Align wiring port of fixture (1) to junction box (not included) then using 2 screws (3) to secure it temporary to the ceiling. Proceed to mark each location through the four holes on outer perimeter of the fixture for additional support. Take fixture down by removing the two screws (3). Drill small pilot hole at center of each marked locations. If there is a wood joist, use a suitable wood screw (4) to mount the fixture. Where there is no wood joist to screw into, drill a larger 1/4" hole for plastic anchor (5) or use a 1/4" toggle bolt (not included) of suitable length to mount channel securely to the ceiling.

C

Wiring – All wiring must take place inside junction box (not included)

Caution: Make sure power is off at fuse or circuit breaker box. Check power wires for damage or scrapes. If power supply wires are within three inches of the LED driver, use wire suitable for at least 90°C (194°F).

Note: Most dwellings built before 1985 have supply wire rated to 60°C. Consult a qualified electrician to ensure correct branch circuit conductor before installing.

11182 INSTALLATION INSTRUCTIONS WITH OPTIONAL BACK-UP BATTERY FOR ARCHITECTURAL ROUND SURFACE-MOUNTED LED LIGHT

Step 2 – Wiring fixture

- Make all wire connections to appropriate wire. Secure with wire nuts (provided).
- Connect the green wire from the fixture to the supply power source ground wire.
- Connect the white wire from the fixture to the white (N) wire from the supply power source.
- Connect the black wire from the fixture to the black (L) wire from the supply power source.
- Do not mix wires. Pull on each wire lead to make sure connections are secure. Make certain no bare wires are exposed outside of wire connectors. Tuck all connections neatly into the junction box.

Step 3 – Mounting

Install fixture (1) to the ceiling using hardware as described in accordance with Step C to secure it.

Step 4 – Color changing temperature adjustment, CCT (if desired)

Adjust CCT switch inside the fixture according to the desired color temperature of 2700K, 3000K, 3500K, 4000K, or 5000K as shown below. Note: Fixture is preset to 3000K from factory.

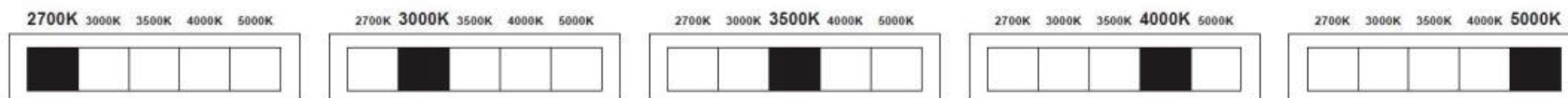











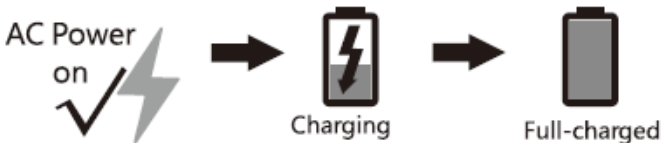







Step 5 – Diffuser

Install diffuser (2) by gently pushing one side up inside top corner of the fixture in slant position then slowly lift the other side up until it is completely inside the fixture then release diffuser as it is securely supported on the flanges.

Step 6 – Restore power at fuse or circuit breaker box.

11182 INSTALLATION INSTRUCTIONS WITH OPTIONAL BACK-UP BATTERY FOR ARCHITECTURAL ROUND SURFACE-MOUNTED LED LIGHT

Emergency Battery:

Operation							
<p>AC Operation: AC power is present, The LED load from the LED driver is normal power supply, AC LED driver output current can not exceed 150W or 4A, the emergency driver is charging in a standby mode. The green LED light flashes indicates that it is charging. The green LED light on indicates that it is full charged. After the AC power supply working 48h, The emergency LED drive will automatically from AC power working switch into emergency working mode for 30S every month and then automatically backs to the working mode of the AC power supply, the AC power supply works per year for automatically from the AC power mode backs to the working emergency mode Until the emergency discharge is completed.</p> <p>Emergency operation: When the AC power goes out, The emergency driver detects the AC power outage and automatically switch to the emergency mode.</p>							
							
Indicator light introduction	<table border="1" style="width: 100%; text-align: center;"> <tr> <td style="width: 33%;"> Green Flashing Charging ①</td> <td style="width: 33%;"> Green ON Full-charged ②</td> <td style="width: 33%;"> Red ON Discharging(emergency mode) ③</td> </tr> <tr> <td> Red Flashing Discharging(emergency mode) finished soon ④</td> <td colspan="2"> Yellow ON Error ⑤</td> </tr> </table>	 Green Flashing Charging ①	 Green ON Full-charged ②	 Red ON Discharging(emergency mode) ③	 Red Flashing Discharging(emergency mode) finished soon ④	 Yellow ON Error ⑤	
 Green Flashing Charging ①	 Green ON Full-charged ②	 Red ON Discharging(emergency mode) ③					
 Red Flashing Discharging(emergency mode) finished soon ④	 Yellow ON Error ⑤						
Test switch introduction							

11182 INSTALLATION INSTRUCTIONS WITH OPTIONAL BACK-UP BATTERY FOR ARCHITECTURAL ROUND SURFACE-MOUNTED LED LIGHT

TOOL(S) NEEDED:

Option 1) Cordless drill and an elbow or L-shape adapter with Philips Insert Bit extension.



Option 2) Flexible Screwdriver with Philips Insert Bit.

