

Project Name: _____ Type: _____ Quantity: _____

INTENDED USE

Featuring a large center light source with 6 additional lights in its outer ring light, our pendant mount LED fixture with sound absorbing acoustic felt is 100% polyester fiber and 0.35" thick. Offering 35+ felt finish options, this product can be ordered with two finishes, for top & bottom and for the side faces of the fixture.

FEATURES

Construction: Sound absorbing acoustic felt is 100% polyester fiber and 0.35" thick. Polyester Fiber contains at least 55% recycled content.

Pendant Mounting: 6' pendant mount hanging kit

Voltage: 120V

Dimming: ELV/TRIAC Dimming Compatible

Color Temperature: 3000K Soft White

CRI: 80+

LED Life: 50,000 hrs

Power Factor: >0.90

Listings: Made in the USA

Warranty: 1 Years carefree for parts & components (labor not included)

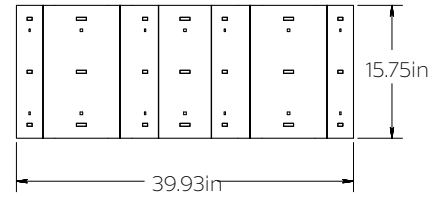
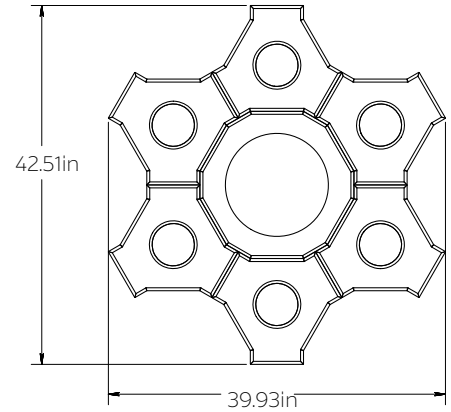
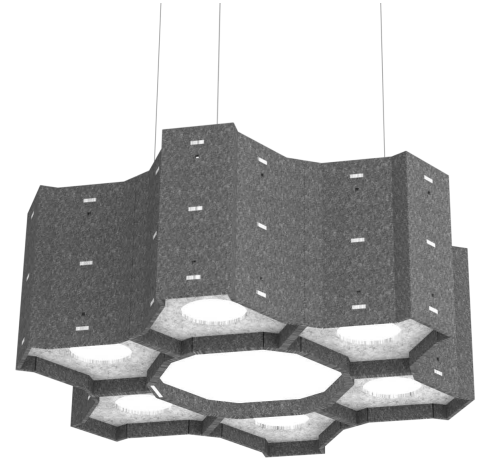

Alcon Lighting 11168 LED Pendant with Sound Absorbing Acoustics

ORDERING INFORMATION Example: (11168-40-WH-DG)

Model	Wattage Lumen	Acoustic Felt Finish A ¹	Acoustic Felt Finish B ²
11168	40 40 Watts 1200 Lum 130 130 Watts 9100 Lum	WH White LG Light Gray DG Dark Gray XX ³ Custom colors	WH White LG Light Gray DG Dark Gray XX ³ Custom colors

¹ Refers to the top and bottom faces of acoustic felt
² Refers to the vertical side faces of acoustic felt
³ View page 2 for available custom color finishes

INTENDED USE

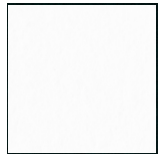

WH
White

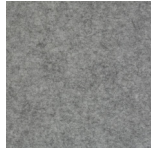

LG
Light Gray



PG
Pure Gray

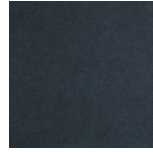

ST
Steel



DG
Dark Gray



TB
True Black



GW
Grey Wash*



BRU
Brunette



IVR
Ivory



CRE
Cream



LAT
Latte



SMB
Smoky Beige



TAU
Taupe



SPE
Speckled Earth



TAN
Tangerine

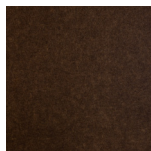

ESP
Espresso

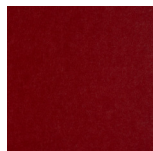

BIR
Big Red

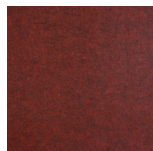

LAV
Lava

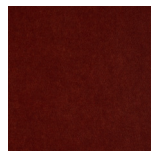

BER
Berry



CAR
Caramel



MAR
Marigold

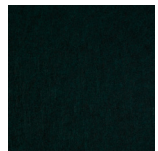

EMR
Emerald



SUO
Sunkist Orange

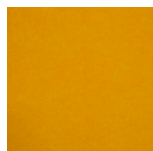

YEL
Yellow

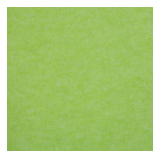

GRA
Green Apple



AVO
Avocado



MOS
Moss



DRG
Dark Green

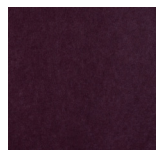

EGG
Eggplant



ARI
Arctic Ice



BL
Blue



AZU
Azure



DEN
Denim

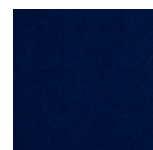

INB
Indigo Blue

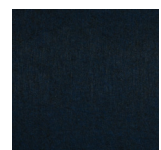

DEB
Deep Blue

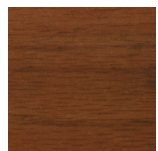

PMB
Pecan Medium
Brown*



BLB
Birch Light
Brown*



RS
Rich Soil*