

Project Name: \_\_\_\_\_ Type: \_\_\_\_\_ Quantity: \_\_\_\_\_

**INTENDED USE**

Offered in three sizes, our 11164 fixture features sound absorbing acoustic felt is 100% polyester fiber and 0.35" thick. At the center, the LED light is capable of supplying work spaces with lumens from up to 2500L. 35+ felt finish options are available for your choosing.

**FEATURES**

- Construction:** Sound absorbing acoustic felt is 100% polyester fiber and 0.35" thick. Polyester Fiber contains at least 55% recycled content.
- Pendant Mounting:** 6' pendant mount hanging kit
- Voltage:** 120V
- Dimming:** ELV/TRIAC Dimming Compatible
- Color Temperature:** 3000K Soft White
- CRI:** 80+
- LED Life:** 50,000 hrs
- Power Factor:** >0.90
- Listings:** Made in the USA
- Warranty:** 1 Years carefree for parts & components (labor not included)

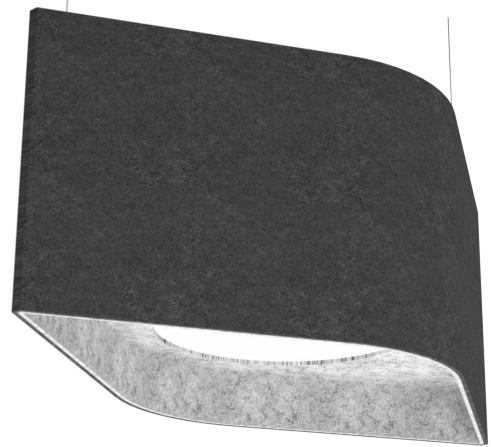

Size	W	L	D	H
Small	11"	19"	7"	18"
Medium	14"	27"	11"	18"
Large	18"	34"	14"	18"

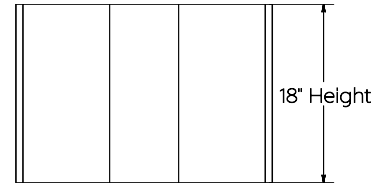
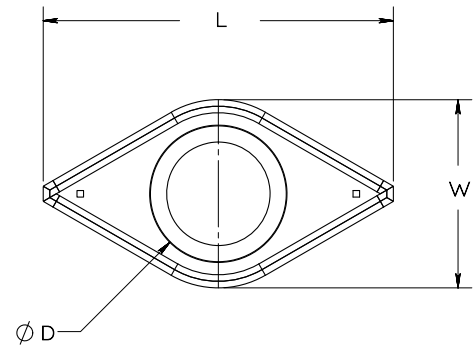

**ORDERING INFORMATION** Example: (11164-SM-15-WH)

Model	Width   Length   Diameter	Wattage   Lumen	Acoustic Felt Finish
11164	SM 11"W x 19"L x 7"D	15 15 Watts   1000 Lum	WH White
	MD 14"W x 27"L x 11"D	28 28 Watts   1700 Lum	LG Light Gray
	LG 18"W x 34"L x 14"D	40 40 Watts   2500 Lum	DG Dark Gray
			XX <sup>1</sup> Custom colors

<sup>1</sup> View page 2 for available custom color finishes

### INTENDED USE

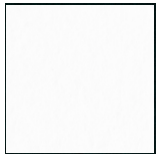

**WH**  
White

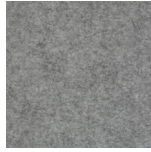

**LG**  
Light Gray



**PG**  
Pure Gray

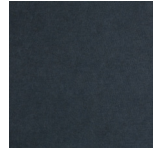

**ST**  
Steel



**DG**  
Dark Gray



**TB**  
True Black



**GW**  
Grey Wash\*



**BRU**  
Brunette



**IVR**  
Ivory



**CRE**  
Cream



**LAT**  
Latte



**SMB**  
Smoky Beige



**TAU**  
Taupe



**SPE**  
Speckled Earth



**TAN**  
Tangerine

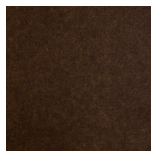

**ESP**  
Espresso

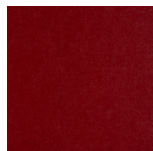

**BIR**  
Big Red

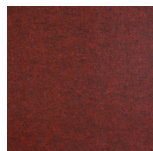

**LAV**  
Lava

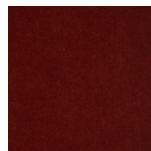

**BER**  
Berry



**CAR**  
Caramel



**MAR**  
Marigold

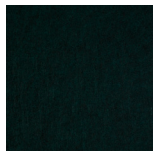

**EMR**  
Emerald



**SUO**  
Sunkist Orange

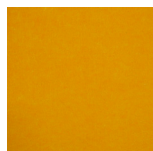

**YEL**  
Yellow

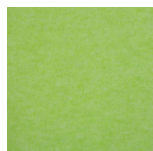

**GRA**  
Green Apple



**AVO**  
Avocado



**MOS**  
Moss



**DRG**  
Dark Green

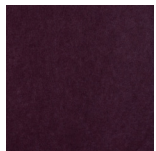

**EGG**  
Eggplant



**ARI**  
Arctic Ice



**BL**  
Blue



**AZU**  
Azure



**DEN**  
Denim

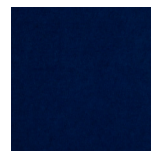

**INB**  
Indigo Blue

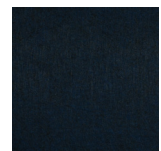

**DEB**  
Deep Blue

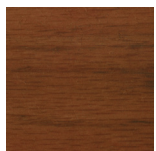

**PMB**  
Pecan Medium Brown\*



**BLB**  
Birch Light Brown\*



**RS**  
Rich Soil\*