

SOLID STATE AREA LIGHTING

RAZAR-PT2 SERIES-PLED

S P E C I F I C A T I O N S

OPTICAL HOUSING

Heavy cast low copper aluminum (A356 alloy; <0.2% copper) assembly with integral cooling fins. The Optical Panel mounting surface is milled flat (surface variance $\leq \pm .003"$) to facilitate thermal transfer of heat to housing and cooling fins. Minimum wall thickness is .188". All hardware is stainless steel.

TWIN ARM POST TOP MOUNTING/ELECTRICAL COMPARTMENT

Two (2) 1/2" Sch.40 round aluminum arms are welded to a cast low copper aluminum (A356 alloy; <0.2% Cu) pole top tenon fitter which also serves as the LED Driver and wiring compartment. Tenon maximum 27/8" diameter x 31/2" height. All exposed hardware is stainless steel.

PLED™ OPTICS

Emitters (LED's) are arrayed on a metal core PCB panel with each emitter located on a copper thermal transfer pad and enclosed by an LED refractor. LED optics completely seal each individual emitter to meet an IP66 rating. In asymmetric distributions, a micro-reflector inside the refractor re-directs the house side emitter output towards the street side and functions as a house side shielding element. Refractors are injection molded H12 acrylic. Each LED refractor is sealed to the PCB over an emitter and all refractors are retained by an aluminum frame. Any one Panel, or group of Panels in a luminaire, have the same optical pattern. LED refractors produce standard site/area distributions. Panels are field replaceable and field rotatable in 90° increments.

LED DRIVERS

Constant current electronic with a power factor of >.90 and a minimum operating temperature of -40°F/-40°C. Driver(s) is/are UL and cUL recognized and mounted directly against the Electrical Housing to facilitate thermal transfer, held down by universal clamps to facilitate easy removal. In-line terminal blocks facilitate wiring between the driver and optical arrays. Drivers accept an input of 120-277V, 50/60Hz or 347V-480V, 50,60Hz. (0 - 10V dimmable driver is standard. Driver has a minimum of 3KV internal surge protection. Luminaire supplied with 20KV surge protector for field accessible installation.)

AMBER LED's

PCA (Phosphor Converted Amber) LED's utilize phosphors to create color output similar to LPS lamps and have a slight output in the blue spectral bandwidth. **TRA** (True Amber) LED's utilize material that emits light in the amber spectral bandwidth only without the use of phosphors.

FINISH

Electrostatically applied TGIC Polyester Powder Coat on substrate prepared with 20 PSI power wash at 140°F. Four step sand blast and iron phosphate pretreatment for protection and paint adhesion. 400°F bake for maximum hardness and durability. Texture finish is standard.

PROJECT NAME: _____

FIXTURE TYPE: _____

GET A QUOTE >



RZR-PT2 PLED

PATENT PENDING

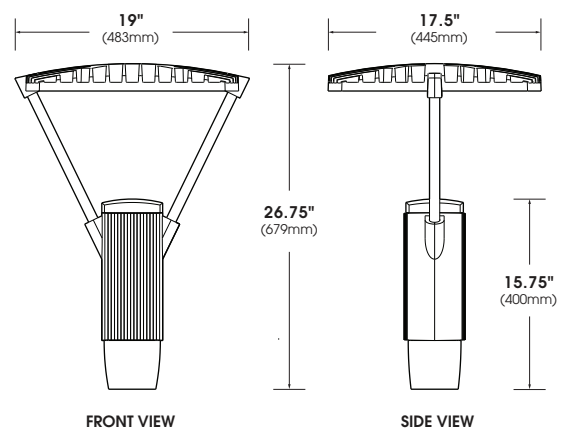

2018358



RZR-PT2 SERIES - PLED

S P E C I F I C A T I O N S

PLED™ MODULES

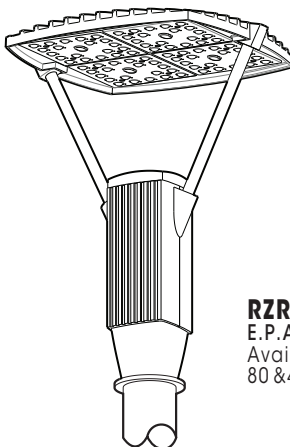

RZR LED POST TOP2
E.P.A.= 1.08
Available in:
80 & 40 LED Array

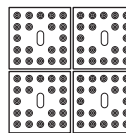

80 LED Array

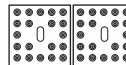











40 LED Array

Approximate Average Lumens – 4000K
(Lumens median of all distributions)

	350mA			525mA			700mA			1050mA		
	Watts	Lumens	HID Eq.	Watts	Lumens	HID Eq.	Watts	Lumens	HID Eq.	Watts	Lumens	HID Eq.
40	45	5997	70-100	66	8653	100-150	87	10995	175	134	14647	200-250
80	87	11622	175-200	131	16736	200-250	174	21235	400	N/A	N/A	N/A

Spec/Order Example: RZR-PT2-LED/PLED-V-SQ/80LED-700mA/NW/277/RAL9005

S P E C / O R D E R I N G I N F O R M A T I O N

MODEL	OPTICS	LED MODE			VOLTAGE	FINISH	OPTIONS
MODEL	OPTICS	NO. LEDs	DRIVE CURRENT	COLOR TEMP - CCT	VOLTAGE	FINISH	OPTIONS
<input type="checkbox"/> RZR-PT2	<input type="checkbox"/> TYPE II PLED-II  <input type="checkbox"/> TYPE II FRONT ROW PLED-II-FR  <input type="checkbox"/> TYPE II MEDIAN ILLUMINATOR PLED-II-ML  <input type="checkbox"/> TYPE III PLED-III-M  <input type="checkbox"/> TYPE III PLED-III-W  <input type="checkbox"/> TYPE IV PLED-IV  <input type="checkbox"/> TYPE IV PLED-IV-FT  <input type="checkbox"/> TYPE V NARROW PLED-V-SQ-N  <input type="checkbox"/> TYPE V PLED-V-SQ-M  <input type="checkbox"/> TYPE V PLED-V-SQ-W 	<input type="checkbox"/> 80LED <input type="checkbox"/> 40LED	<input type="checkbox"/> 350mA <input type="checkbox"/> 525mA <input type="checkbox"/> 700mA ¹ <input type="checkbox"/> 1050mA ¹ (40LED ONLY)	<input type="checkbox"/> NW (4000K)* *STANDARD <input type="checkbox"/> CW (5000K) <input type="checkbox"/> WW (3000K) CONSULT FACTORY FOR OTHER LED COLORS <input type="checkbox"/> AMBER ² <input type="checkbox"/> PHOSPHOR CONVERTED AMBER PCA <input type="checkbox"/> TRUE AMBER ³ TRA	<input type="checkbox"/> 120 <input type="checkbox"/> 208 <input type="checkbox"/> 240 <input type="checkbox"/> 277 <input type="checkbox"/> 347 <input type="checkbox"/> 480	STANDARD TEXTURED FINISH <input type="checkbox"/> BLACK RAL-9005-T <input type="checkbox"/> WHITE RAL-9003-T <input type="checkbox"/> GREY RAL-7004-T <input type="checkbox"/> DARK BRONZE RAL-8019-T <input type="checkbox"/> GREEN RAL-6005-T FOR SMOOTH FINISH REPLACE SUFFIX "T" WITH SUFFIX "S" (EXAMPLE: RAL-9005-S) CONSULT FACTORY FOR CUSTOM COLORS	<input type="checkbox"/> HIGH-LOW DIMMING FOR HARDWIRED SWITCHING OR NONINTEGRATED MOTION SENSOR HLSW <input type="checkbox"/> INTERNAL HOUSE SIDE SHIELD ... HS-PLED <input type="checkbox"/> PHOTO CELL + VOLTAGE (EXAMPLE: PC120V) ... PC+V <input type="checkbox"/> TWIST LOCK RECEPTACLE ONLY ... TPR <input type="checkbox"/> 7-PIN TWIST LOCK RECEPTACLE ONLY ... TPR7 <input type="checkbox"/> SINGLE FUSE (120V, 277V, 347V) ... SF <input type="checkbox"/> DOUBLE FUSE (208V, 240V, 480V) ... DF <input type="checkbox"/> STEP DIM MOTION SENSOR (PROGRAMMED 50/100) MS-F211 <input type="checkbox"/> REMOTE MOTION SENSOR CONFIGURATOR MS-FC10
<p>NOTES: 1 - 700mA and 1050mA NOT FOR USE WITH TRA LED'S 2 - NARROW BAND AMBERS HAVE NO DEFINABLE CCT EQUIVALENT 3 - AVAILABLE IN 350mA & 525mA DRIVE CURRENTS ONLY</p>							



RZR-PT2 SERIES - PLED

LED/ELECTRICAL GUIDE

LED COUNT	SOURCE TYPE	SOURCE	INITIAL LUMENS - 4000K CCT	INITIAL LUMENS - 3000K CCT	INITIAL LUMENS - 5000K CCT	L70 GREATER THAN (HR)	STARTING TEMP.	SYSTEM WATTS	VOLTS	MAX INPUT AMPS
40	LED	40 PLED Optical Module - 350mA	5,585 - 6,408	5,306 - 6,088	5,864 - 6,729	60,000+	-20°F	45	120 277	0.38 0.17
40	LED	40 PLED Optical Module - 525mA	8,059 - 9,246	7,656 - 8,784	8,462 - 9,709	60,000+	-20°F	66	120 277	0.55 0.24
40	LED	40 PLED Optical Module - 700mA	10,240 - 11,749	9,728 - 11,162	10,752 - 12,337	60,000+	-20°F	87	120 277	0.73 0.32
40	LED	40 PLED Optical Module - 1050mA	13,642 - 15,652	12,960 - 14,870	14,324 - 16,435	60,000+	-20°F	134	120 277	1.12 0.49
80	LED	80 PLED Optical Module - 350mA	10,824 - 12,419	10,283 - 11,798	11,365 - 13,040	60,000+	-20°F	87	120 277	0.75 0.33
80	LED	80 PLED Optical Module - 525mA	15,587 - 17,884	14,808 - 16,990	16,366 - 18,778	60,000+	-20°F	131	120 277	1.10 0.48
80	LED	80 PLED Optical Module - 700mA	19,767 - 22,680	18,779 - 21,546	20,755 - 23,814	60,000+	-20°F	174	120 277	1.45 0.63

NOTES:

1. Max Input Amps is the highest of starting, operating, or open circuit currents
2. Lumen values for LED Modules vary according to the distribution type
3. System Watts includes the source watts and all driver components.
4. Fuse value should be sufficient to protect all wiring components. For electronic driver and LED component protection, use surge suppressor supplied with luminaire.
Note: Surge suppressors are considered a perishable device.
5. L70(10K) - TM-21 6x rule applied

WARNING: All fixtures must be installed in accordance with local codes or the National Electrical Code. Failure to do so may result in serious personal injury.

