

SOLID STATE BOLLARDS

BDA SERIES-LED

SPECIFICATIONS

BOLLARD

Durable corrosion resistant extruded and cast aluminum construction. 1/4" wall thickness.

LED POWER ARRAY™

Three-dimensional array consisting of 6 individual LED tubes for the BDA8 model and 4 individual LED tubes for the BDA6 model, which are fastened to a retaining plate equally spaced to provide 360° of even illumination output. Each LED tube consists of a circuit board populated with a multiple of LED's which is fastened to a radial aluminum heat sink. A white polycarbonate lens and end caps protect each LED tube's internal components and provides diffusion to prevent shadowing and striations.

INTERNAL LOUVER (IL) - A specular louver stack conceals the inner LED Power Array Module and provides uplight and glare control through the external clear polycarbonate lens.

CAST LOUVER (CL) - External cast aluminum louver stack protects the internal LED Power Array Module and provides uplight and glare control. An internal clear polycarbonate lens is integrated with the LED Power Array Module.

OPAL LENS (WP) - Exterior white polycarbonate lens protects the internal LED Power Array Module and provides a uniform white glow.

RADIAL LED MODULE

LED'S are mounted to a circular heatsink in a radial array. The radial LED module is concealed in the cap of the bollard. LED's are not directly visible from angles above 90°.

PARABOLIC REFLECTOR (PR) - A specular Parabolic Reflector reflects a portion of the distribution from the radial LED module and provides a uniform wide angle throw through the outer clear polycarbonate lens.

LED EMITTERS

High Output LED's are driven at 350mA for nominal 1 Watt output each. 70CRI Minimum. LED's are available in standard Neutral White (4000K), or optional Cool White (5000K) or Warm White (3000K). Consult Factory for other LED options.

LED DRIVER

UL and CUL recognized Constant Current LED drivers operate on input voltages from 120-277VAC, 50/60hz. Consult Factory for (347-480VAC). Driver is mechanically fastened to a retaining bracket. Driver has a minimum 4KV of internal surge protection, 10KV & 20KV Surge Protector optional. Dimmable and High-Low Driver options available.

FINISH

Polyester powder coat incorporates four step iron phosphate process to pretreat metal surface for maximum adhesion. Top coat is baked at 400°F for maximum hardness and exterior durability.

PROJECT NAME: _____

FIXTURE TYPE: _____

GET A QUOTE >



BDA

BDA8 SHOWN WITH -PR OPTICS

PATENT PENDING

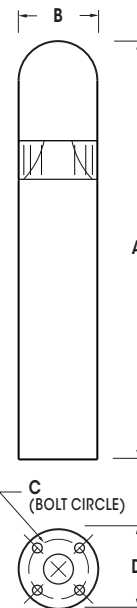

BOLLARD	A	B	C	D
BDA8	42" 1067mm	8" 203mm	6" 152mm	8" 203mm
BDA6	42" 1067mm	6" 152mm	4" 102mm	6" 152mm



2018214



BDA SERIES-LED

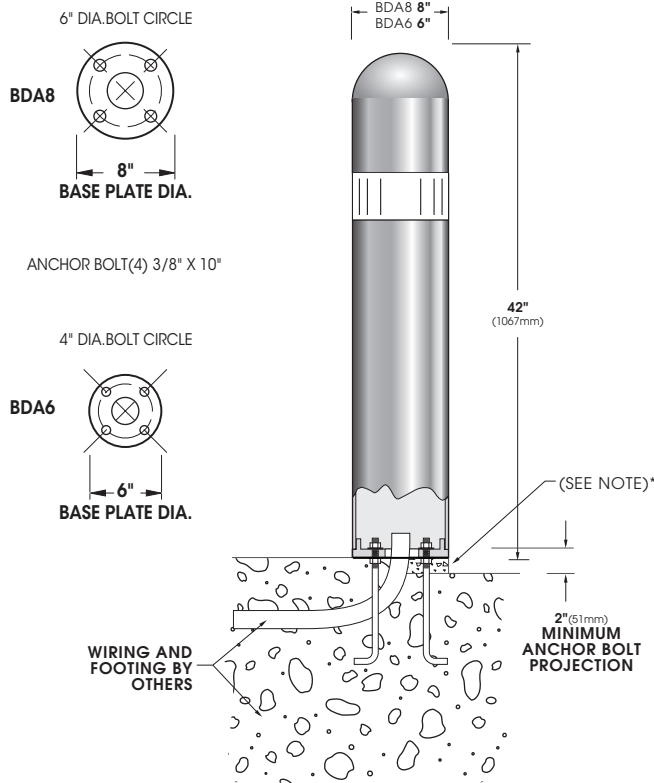

SPECIFICATIONS

INSTALLATION



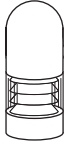

*When mounting in soil, anchor bolt fasteners and other hardware must be protected from soil by grouting.

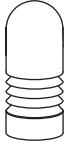
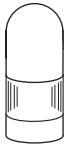
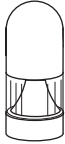
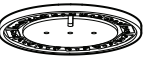
OPTICS

INTERNAL LOUVER SUPPLIED WITH CLEAR POLYCARBONATE LENS		IL	 VPA - Vertical Array BDA8 Available in: 36 LED Max BDA6 Available in: 24LED Max
CAST LOUVER		CL	
OPAL POLYCARBONATE		WA	
PARABOLIC REFLECTOR		PR	 RADIAL LED Module BDA8 Available in: 18 LED Module BDA6 Available in: 12 LED Module

Spec/Order Example: BDA6-IL/24LED277NW/WM/RAL-7004-T/DUP

SPEC / ORDERING INFORMATION

BOLLARD	OPTICS	# of LED's	COLOR	VOLTAGE	MOUNTING	FINISH	OPTIONS
<input type="checkbox"/> BDA8-LED	<input type="checkbox"/> INTERNAL LOUVER IL	<input type="checkbox"/> 36LED ¹	<input type="checkbox"/> NW (4000K) Standard		<input type="checkbox"/> GROUND INSTALLATION  <input type="checkbox"/> WALL MOUNT WM 	<input type="checkbox"/> BLACK RAL-9005-T <input type="checkbox"/> WHITE RAL-9003-T <input type="checkbox"/> GREY RAL-7004-T <input type="checkbox"/> DARK BRONZE RAL-8019-T <input type="checkbox"/> GREEN RAL-6005-T	<input type="checkbox"/> DIMMABLE DRIVER (0-10V PROVIDED) DIM <input type="checkbox"/> HIGH-LOW DIMMING FOR HARDWIRED SWITCHING OR NONINTEGRATED MOTION SENSOR HLSW <input type="checkbox"/> INTERNAL HOUSE SIDE SHIELD HS <input type="checkbox"/> DUPLEX RECEPTACLE DUP <input type="checkbox"/> GROUND FAULT RECEPTACLE GFI <input type="checkbox"/> 10KV SURGE PROTECTOR 10SP <input type="checkbox"/> 20KV SURGE PROTECTOR (277V & 480V Only) 20SP
<input type="checkbox"/> BDA6-LED	<input type="checkbox"/> CAST LOUVER CL <input type="checkbox"/> OPAL POLYCARBONATE WP*	<input type="checkbox"/> 24LED	<input type="checkbox"/> CW (5000K) <input type="checkbox"/> WW (3000K) OTHER LED COLORS AVAILABLE CONSULT FACTORY				
	RADIAL LED MODULE						
	<input type="checkbox"/> PARABOLIC REFLECTOR PR	<input type="checkbox"/> 18LED ¹ <input type="checkbox"/> 12LED ²	<input type="checkbox"/> 120 <input type="checkbox"/> 208 <input type="checkbox"/> 240 <input type="checkbox"/> 277 <input type="checkbox"/> 347 <input type="checkbox"/> 480				
	*WP OPTICS USE OPAL POLYCARBONATE LENS	NOTES: 1 - AVAILABLE IN BDA8 ONLY. 2 - AVAILABLE IN BDA6 ONLY.					

