

3" LED

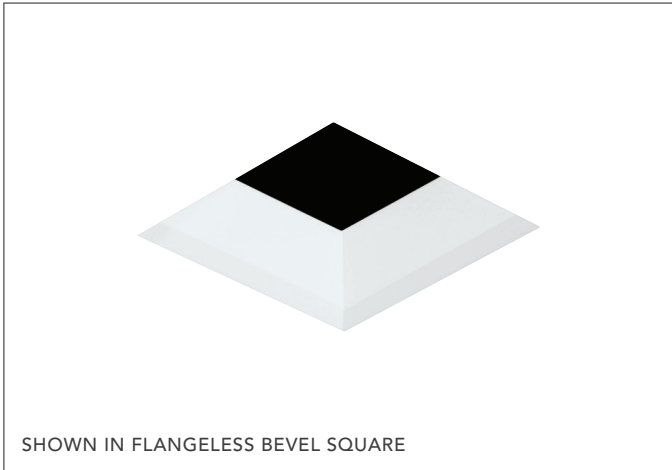

LOW PROFILE ADJUSTABLE DOWNLIGHT



SHOWN IN FLANGELESS BEVEL SQUARE

THE ELEMENT 3" LED LOW-PROFILE ADJUSTABLE DOWNLIGHT PROVIDES A BEAUTIFUL ARCHITECTURAL APPEARANCE AND HIGH PERFORMANCE FOR SHALLOW CEILING PLENUM INSTALLATIONS. DESIGNED WITH AN ULTRA-SHALLOW 4" HOUSING AND UTILIZING THE SAME TRIM PIECES AS THE REST OF THE ELEMENT 3" LED SERIES, CAN BE USED IN CONJUNCTION WITH THE ENTIRE 3" FAMILY AND REMAIN UNDETECTABLE. IDEAL FOR SPACE CONSTRAINED ENVIRONMENTS SUCH AS ELEVATORS AND HEALTHCARE SOFFITS. COMPLETE ADJUSTABILITY ALLOWS FOR LOCKABLE HOT AIMING WITH 0°-35° TILT AND 361° ROTATION, ELIMINATING DEADSPOTS. WOOD CEILING OPTION ALLOWS FOR A SMOOTH, FLANGELESS APPEARANCE USING ANY FLANGELESS TRIM.

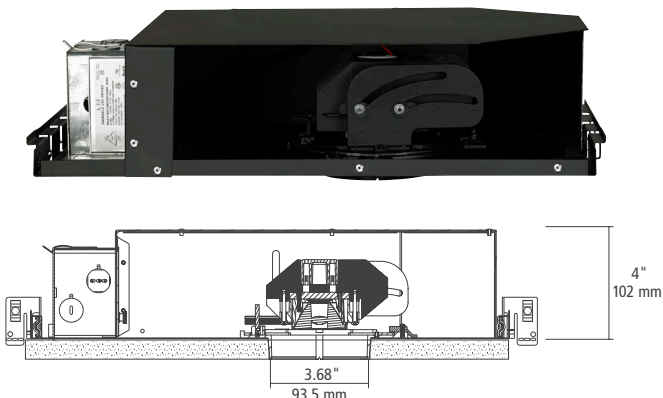

LAMPING & OPTICS

- High Output:
 - 1500/1200 net lumens at 3000K (80 CRI/90 CRI)
 - 83/67 net lumens per watt at 3000K (80 CRI/90 CRI)
- Low Output:
 - 1000/800 net lumens at 3000K (80 CRI/90 CRI)
 - 83/67 net lumens per watt at 3000K (80 CRI/90 CRI)
- CA Title 24 Compliant with 90 CRI versions
- 2700K, 3000K, 3500K with 3-step color binning
- Field-changeable optic: 15°, 25°, 40° (CBCP: 5618, 3856, 1575 respectively). Accepts two optical controls and an optional trim mounted lens

POWER / POWER SUPPLY

- High Output consumes 18 watts, Low Output consumes 12 watts
- Constant current driver with +.9 power factor and +80% efficiency
- Dimmable with ELV or incandescent dimmer to 2%-15% depending on dimmer; see element-lighting.com for compatibility
- Optional 0-10V dimming
- Consult Quotes Dept for alternate or custom driver selections

TRIMS

- Die cast aluminum with minimal thickness
- Available in flanged or flangeless ceiling appearance
- Lensed and shower aperture includes Solite™ soft focus lens
- White can be field painted to match adjacent finishes
- Accommodates up to 2.5" drywall ceiling thickness, depending on trim.
- Wood ceiling option accommodates variable ceiling thickness. Consult instructions for details.

HOUSING

- IC/Non-IC/Chicago Plenum 11.5" x 17.5" x 4"
- Constructed of heavy gauge cold rolled steel with durable matte black powder coat finish
- 3-7/8" ceiling opening
- Includes integral junction box approved for branch circuit through wiring
- ETL listed. Damp listed. Shower version wet listed.

Visit www.element-lighting.com for full photometrics.

GENERATION BRANDS



2015 Tech Lighting, L.L.C. All rights reserved. The "Element" graphic is a registered trademark of Element. Element reserves the right to change specifications for product improvements without notification.

ELEMENT
by Tech Lighting®

7400 Linder Avenue, Skokie, Illinois 60077 T 847.410.4400 F 847.410.4500

LOW PROFILE ADJUSTABLE DOWNLIGHT TRIMS

ROUND

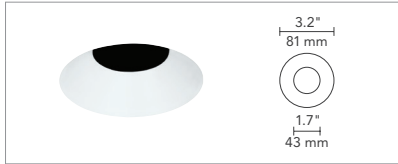

FLANGELESS BEVEL

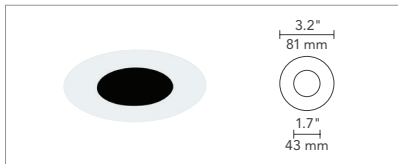

FLANGELESS FLAT



FLANGED BEVEL

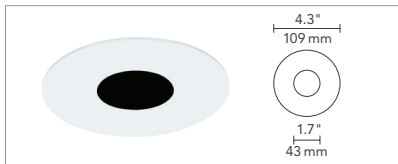

FLANGED FLAT

SQUARE

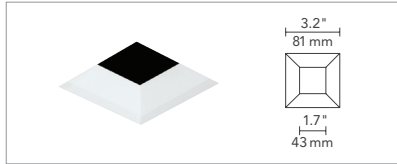

FLANGELESS BEVEL

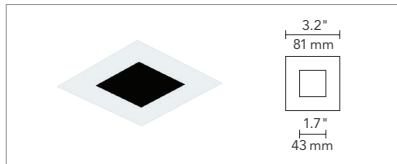

FLANGELESS FLAT

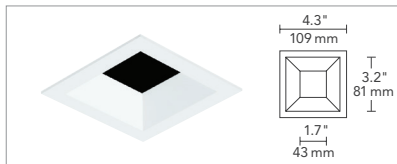

FLANGED BEVEL

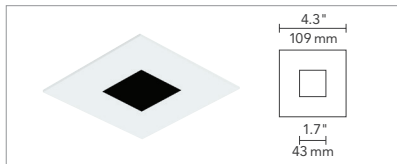

FLANGED FLAT

FINISH



ANTIQUE
BRONZE



BLACK



SATIN
NICKEL



WHITE
(PAINTABLE)

3" HOUSING

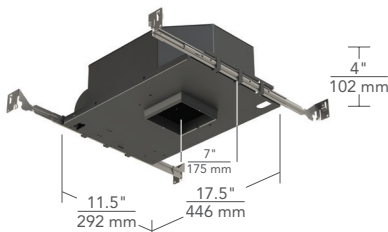

IC / NON-IC / CHICAGO PLENUM

LOW PROFILE ADJUSTABLE DOWNLIGHT WOOD CEILING OPTION / FLANGELESS TRIMS

ROUND



FLANGELESS BEVEL (ANTIQUE BRONZE)



FLANGELESS FLAT (ANTIQUE BRONZE)



FLANGELESS BEVEL (SATIN NICKEL)



FLANGELESS FLAT (SATIN NICKEL)

SQUARE

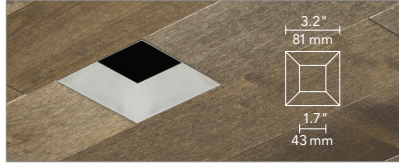

FLANGELESS BEVEL (ANTIQUE BRONZE)



FLANGELESS FLAT (ANTIQUE BRONZE)



FLANGELESS BEVEL (SATIN NICKEL)



FLANGELESS FLAT (SATIN NICKEL)

FINISH



ANTIQUE BRONZE



BLACK



SATIN NICKEL



WHITE (PAINTABLE)

ADJUSTABLE TRIM ADAPTER

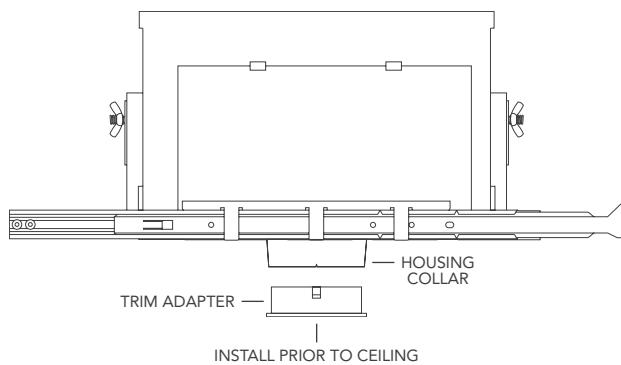

TRIM ADAPTER INSTALLED

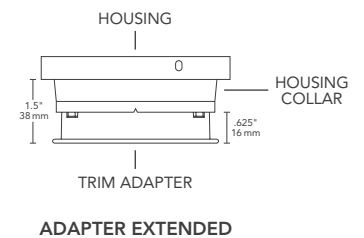
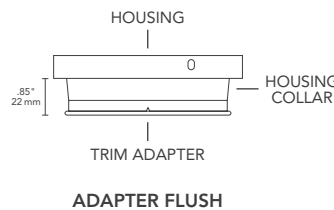

Wood ceiling housings ("WC" designation in the ordering grid) ship with an adjustable trim adapter that inserts into the housing aperture and allows standard ELEMENT 3" flangeless trims to achieve a truly flangeless, flush ceiling appearance in special applications such as wood or stone installation. For use in new construction.

Consult installation instructions regarding plenum requirements and ceiling thickness ratios.

LOW PROFILE ADJUSTABLE DOWNLIGHT GRIDS

HOUSING

PRODUCT SERIES	CEILING APPEARANCE	LAMP	BEAM SPREAD	FUNCTION	HOUSING RATING	DRIVER	VOLTAGE	
E3R	ELEMENT 3" ROUND	LF FLANGELESS	-LH827 80 CRI, 2700K, HIGH OUTPUT	1 15°	A ADJUSTABLE	S SHALLOW IC/ NON-IC AIRTIGHT	STANDARD ELV (LEAVE BLANK)	120 VOLT (LEAVE BLANK)
E3S	ELEMENT 3" SQUARE	WC WOOD CEILING*	-LH830 80 CRI, 3000K, HIGH OUTPUT	2 25°		CS CHICAGO PLENUM SHALLOW	0-10V DIMMING	-240 240 VOLT -277 277 VOLT
			-LH835 80 CRI, 3500K, HIGH OUTPUT	4 40°				
			-LH927 90 CRI, 2700K, HIGH OUTPUT					
			-LH930 90 CRI, 3000K, HIGH OUTPUT					
			-LH935 90 CRI, 3500K, HIGH OUTPUT					
			-LO827 80 CRI, 2700K, LOW OUTPUT					
			-LO830 80 CRI, 3000K, LOW OUTPUT					
			-LO835 80 CRI, 3500K, LOW OUTPUT					
			-LO927 90 CRI, 2700K, LOW OUTPUT					
			-LO930 90 CRI, 3000K, LOW OUTPUT					
			-LO935 90 CRI, 3500K, LOW OUTPUT					

TRIMS ARE REQUIRED AND MUST BE ORDERED SEPARATELY. *WOOD CEILING OPTION ACCOMMODATES FLANGELESS TRIMS ONLY.

TRIM

PRODUCT SERIES	CEILING APPEARANCE	STYLE	APERTURE	FINISH
E3R	ELEMENT 3" ROUND	L FLANGELESS	B BEVEL	-O NO LENS
		F FLANGED	F FLAT	-H SHOWER
E3S	ELEMENT 3" SQUARE	UP TO 1" CEILING THICKNESS	-L LENSED	S SATIN NICKEL
		F15 FLANGED		W WHITE
		1.1"-1.5" CEILING THICKNESS		
		F20 FLANGED		
		1.6"-2.0" CEILING THICKNESS		
		F25 FLANGED		
		2.0"-2.5" CEILING THICKNESS		

WOOD CEILING OPTION ACCOMMODATES FLANGELESS TRIMS ONLY.

REPLACEMENT OPTIC

	BEAM SPREAD
351LEDHIOPT	15 15°
	25 25°
	40 40°
351LEDHIOPT	

PROJECT INFO

FIXTURE TYPE

FIXTURE QUANTITY

JOB NAME

NOTES
