



Forever Bright

SPECIFICATION FEATURES



Model: **SPJ10-03**
Finish: Matte Bronze

- Finish:** Our naturally etched finishes will withstand the test of time. All finishes are individually treated insuring consistency. Our meticulous application results in a fixture that truly becomes "a one of a kind".
- Electrical:** Available in 8-15V
- Labels:** ETL Standard Wet Label
C-ETL

Path / Area Light

DESCRIPTION

- Model#:** SPJ10-03
- Material:** Solid Brass
- Electrical:** 8-15V
- Engine:** FB-3W-Cone-TA105
- Lumens:** 105
- Color Temp:** 2700 k
- Mounting:** 1/2" NPT. Dual Fin Spike Incl.
- LED:** Nichia

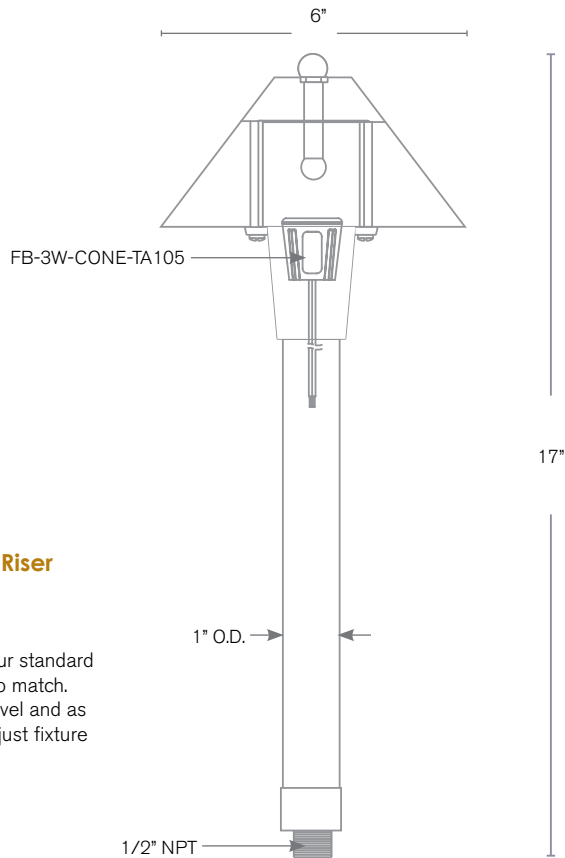

Option:

Adjustable Below Grade Riser

- Model:** SPJ19-03-RBBG
- Shown:** Matte Bronze
- Desc:** Solid brass top fits on our standard perma-post with finish to match. Install fixture at grade level and as the landscape grows adjust fixture height as needed.

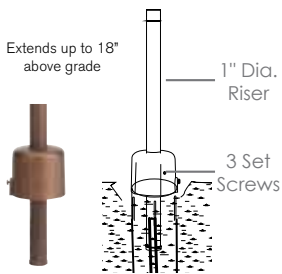

Wet Listed



ORDERING INFORMATION

Model#	Finishes	Wattage	Lumens	Color Temp.	Electrical
SPJ10-03	MBR	3W	105	2700K	8-15V

- V = Verde GM = Gun Metal 3W 105 2700K 8-15V
- M = Moss B = Black 5W 125 4000K
- AG = Aged Brass R = Rusty 6500K
- MBR = Matte Bronze PVDP = PVD Polished
- RC = Raw Copper PVDS = PVD Satin