



LED High Bay fixture ideal for large indoor spaces, including warehouses, gymnasiums and distribution centers that require mounting heights from 15 to 50 feet. Available in 95, 150, 185 and 225 Watt versions with equivalencies from 200 to 400 Watt metal halide fixtures.

Color: White

Weight: 23.2 lbs

Project:

Type:

Prepared By:

Date:

Driver Info

Type: Constant Current
 120V: 1.60A
 208V: 0.92A
 240V: 0.80A
 277V: 0.69A
 Input Watts: 183W
 Efficiency: N/A

LED Info

Watts: 185W
 Color Temp: 5000K (Cool)
 Color Accuracy: 75 CRI
 L70 Lifespan: 100,000
 Lumens: 23,503
 Efficacy: 128 LPW

Technical Specifications

Listings

UL Listing:

Suitable for damp locations

IESNA LM-79 & LM-80 Testing:

RAB LED luminaires have been tested by an independent laboratory in accordance with IESNA LM-79 and LM-80, and have received the Department of Energy "Lighting Facts" label.

DLC Listed:

This product is on the Design Lights Consortium (DLC) Qualified Products List and is eligible for rebates from DLC Member Utilities.

LED Characteristics

Lifespan:

100,000-hour LED lifespan based on IES LM-80 results and TM-21 calculations.

LEDs:

Long-life, high-efficiency surface mount LEDs

Color Stability:

LED Color temperature is warrantied to shift no more than 200K in CCT over a 5 year period.

Color Uniformity:

RAB's range of CCT (Correlated color temperature) follows the guidelines of the American National Standard for Specifications for the Chromaticity of Solid State Lighting (SSL) Products, ANSI C78.377-2008.

Electrical

Drivers:

Two Drivers, Class 2, Constant Current, 100-277VAC, 50-60Hz, 1.1A

THD:

4.8% at 120V, 11.3% at 277V

Power Factor:

99.6% at 120V, 95.1% at 277V

Construction

Ambient Temperature:

Suitable for use 12 hours a day, 5 days a week in 50°C. Suitable for 24/7 use in ambient temperatures up to 30°C. For questions related to fixture operation in high ambient temperatures, contact RAB tech support at 888-722-1000.

Housing:

Extruded aluminum

Lens:

High-transmittance polystyrene

Reflector:

Specular, high-reflectance aluminum with 95% reflectivity

Mounting:

V hooks (chain by others)

Gaskets:

High temperature silicone gaskets.

Finish:

Our environmentally friendly polyester powder coatings are formulated for high-durability and long-lasting color, and contains no VOC or toxic heavy metals.

Green Technology:

Mercury and UV free, and RoHS compliant. Polyester powder coat finish formulated without the use of VOC or toxic heavy metals.

Recommended Mounting Height:

Up to 40 ft.

Other

Equivalency:

RAIL High Bay 185W LED is equivalent to 320W metal halide fixtures.

Warranty:

RAB warrants that our LED products will be free from defects in materials and workmanship for a period of five (5) years from the date of delivery to the end user, including coverage of light output, color stability, driver performance and fixture finish.

California Title 24:

See RAIL with Multi-Level sensor (/WS2 or /WS4) for a compliant California Title 24.

RAIL185W

Dimensions

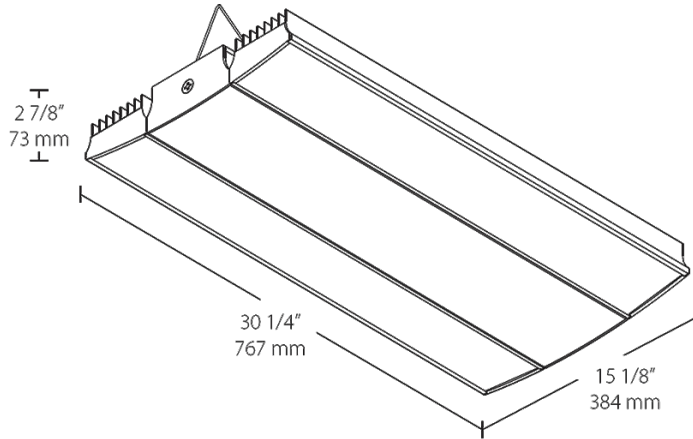

Features

- Ideal for large spaces
- Ultra-high efficacy
- Up to 60% less energy usage than equivalent metal halide fixtures
- 100,000 hour lifespan, virtually maintenance free operation
- Optional 0-10V driver for variable dimming down to 10%

Ordering Matrix

Family	Watts	Color Temp	Finish	Voltage	Dimming
RAIL	95 = 95W 150 = 150W 185 = 185W 225 = 225W	= Cool YN = Warm Neutral N = Neutral	W = White	= 120-277V /480 = 480V	= No Dimming /D10 = Dimmable