

LIBE ROUND S60

Design by: Gianpaolo Rampolla & Andrea Liguori



Lampada LED in legno di Rovere naturale. La diffusione della luce è amplificata da losanghe in cristallo. Cristallo opaco. Base in metallo cromato.

LED lamp in natural oak wood. The diffusion of light is amplified by cut crystal lozenges. Frosted cut crystal. Chromed metal base.

LED-Lampe in Eichenholz natur. Der Licht-Diffusor wird durch lange cut Kristalle verstärkt. Lange opak cut Kristalle. Die Base ist aus verchromtem Metall.

Lampe LED en bois rouvre naturel. La diffusion de la lumière est amplifié par des cristaux cut longues. Longues et opaques cut cristaux. Base en métal chromé.

Lampada de LED en roble natural. La difusion de la luz està amplificada por corte en losange de cristal cut. Cristal cut opaca. Base en metal cromado.

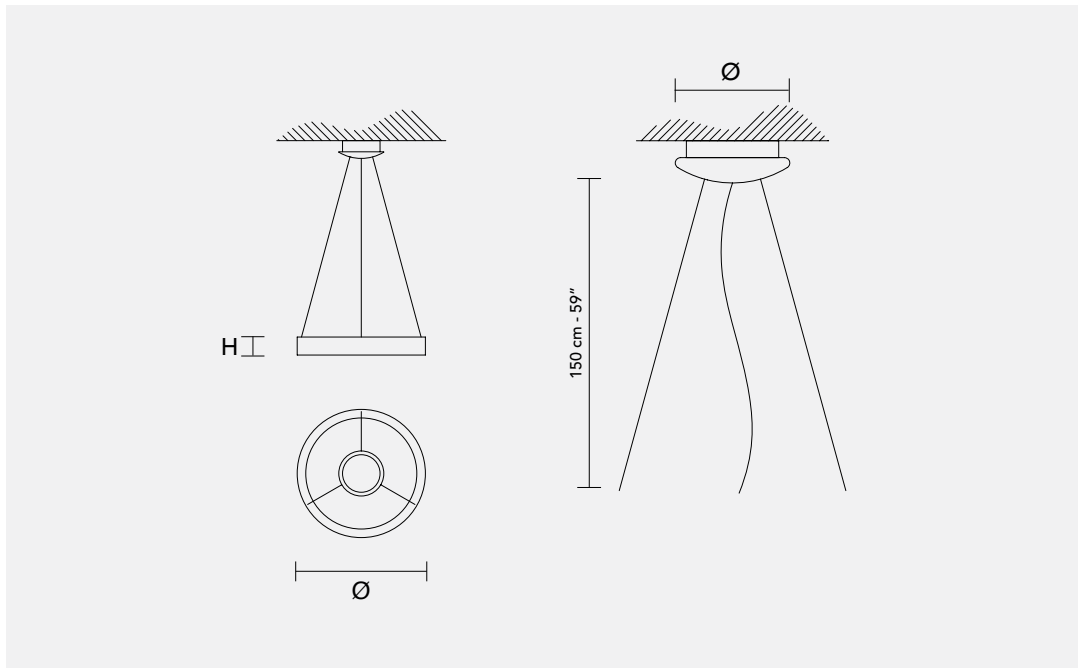

H 8,5 cm
3.34"

Ø 60 cm
23.62"

Peso: 00 kg Imballo: 00 m³
Weight: 00 lb Packing: 00 ft³

Rosone: Metallo verniciato Ø 22 cm
Canopy: Painted Metal Ø 8.66"

LED LED x 48W max 3000K

