

MX MXDRTR / MXT-RTRD308

MX LED Lensed Pinhole - Wet Location

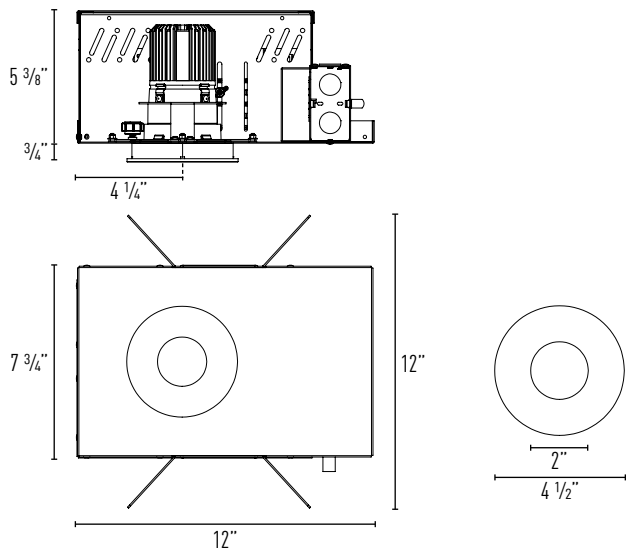

Ceiling Cut Out: 4 1/8"

Catalog Number	System Wattage ¹	CCT / CRI ²	Delivered Lumens ¹	Lumens Per Watt
MXT-RTRD308L030-CR	10W	3000K / 82 CRI	700lm	70
MXT-RTRD308L130-CR	15W	3000K / 82 CRI	1000lm	67

¹ System Wattage include driver and LED Module consumption.

² CCT / CRI Multipliers

2700K / 82 CRI (x0.92), 2700K / 92 CRI (x0.74), 3000K / 82 CRI (x1.0), 3000K / 92 CRI (x0.8), 3500K / 82 CRI (x1.07), 4100K / 82 CRI (x1.08), Crisp White 3000K (x0.85), Class A 3500K (x0.96)

LED LIGHT ENGINE

- 2700K, 3000K, 3500K and 4100K / 82 CRI
- Class A - 3500K, combined GAI and CRI metric
- Crisp White - 3000K, vibrant whites and naturally saturated, warm colors
- 2700K and 3000K / 92 CRI (R9 Value = 59)
- 2 Step MacAdam (2 SDMC)
- LED mounted to die-cast / extruded aluminum heat sink
- 50,000 hours average rated life at 70% output

ELECTRICAL SYSTEM

- Power factor >.9, 50/60Hz
- Multiple dimming drivers available
- This product complies with IEEE C62.41 for surge endurance up to 2.5KV. Additional surge protection recommended. Damage from power surge is not covered by warranty.

HOUSING

Heavy duty black powder coated 18 gauge steel frame. Standard plaster frame accommodates 5/8" ceiling thickness, consult factory for thicker ceilings.

TRIM SPECIFICATION

High quality trims are die-cast using A380 aluminum and finished with durable powder coat available in black or white, black interior standard.

INSTALLATION

Housing types include IC Air-Tight, CCEA (Chicago Plenum), or Non-IC Rated (must specify). Non-IC rated housings must be kept at a minimum of 3" away from insulation. Butterfly brackets and adjustable hanger bars (14"-25") with integral nail included. Butterfly brackets are compatible with C-channel, flat bar hanger and EMT. C-channel is recommended for T-bar ceilings. Bar hangers must be ordered separately. Max. ambient temperature: 131°F (55°C).

EMERGENCY BACKUP

Remote test switch included. Emergency driver operates LED load of up to 7.0 Watts at a nominal 450 lumens for a minimum of 90 minutes.

LISTING / WARRANTY

- 10 Year Intense LED Limited Warranty
- ETL listed to US and Canadian standards for wet locations
- (-AIC Only) Air Tight Certified ASTM E283
- (-AIC Only) ETL listed for direct contact w/ insulation
- (-CP Only) CCEA Chicago Plenum

JOB NAME		CATALOG NUMBER	
NOTES		TYPE	

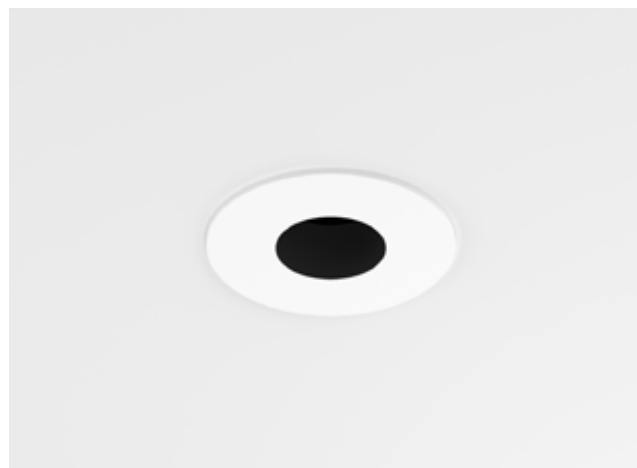

Trim Specification:

Example: MXT-RTRD308WL13012-CR

SERIES		MXT-RTRD308
Round Pinhole with Lens		
FINISH		
Black	B¹	
White	W¹	
WATTAGE		
10 Watts	L0	
15 Watts	L1	
CCT / CRI		
2700K / 82 CRI	27	
2700K / 92 CRI	279	
3000K / 82 CRI	30	
3000K / 92 CRI	309	
3500K / 82 CRI	35	
4100K / 82 CRI	41	
Class A 3500K	CA35	
Crisp White 3000K	CW30	
OPTIC		
12° Spot	12	
24° Narrow Flood	24	
36° Flood	36	
50° Wide Flood	50	
LENS		
Solite	-SL	
Clear Tempered	-CR	
Frosted	-FR	

Housing Specification:

Example: MXDRTR-ICL1

SERIES		MXDRTR-NC
Non-IC LED		
Air Tight IC LED	MXDRTR-IC	
CCEA LED	MXDRTR-CP	
WATTAGE		
10 Watts	L0	
15 Watts	L1	
DIMMING		
Non-Dimming	blank	
ELV Dimming	DELV²	
0-10V Dimming 10%	D10	
eldoLED 0-10V 1%	ED10V1	
eldoLED 0-10V 0.1%	ED10V01	
Lutron Hi-Lume® 1%	LUT1	
Lutron EcoSystem® 1%	LUT	
eldoLED DALI 1%	EDALI1	
eldoLED DALI 0.1%	EDALI01	
VOLTAGE		
120V	blank	
277V	27	
ACCESSORIES		
Emergency Backup	-EM³	
C-Channel Bar Hangers	-I100	
Flat Bar Hangers	-I200	
Wood Joist Bar Hangers	-I400	

Notes:

1. Special order finishes available, consult factory
2. Available in 120V only
3. Access above ceiling required



JOB NAME		CATALOG NUMBER	
NOTES		TYPE	

MXDRTRLO / MXT-RTRD308LO-CR

Report #: L041500702 (12)
L051500704 (24)
L051500706 (36)

CCT / CRI Multipliers:

2700K / 82 CRI (x 0.92)
2700K / 92 CRI (x 0.74)
3000K / 82 CRI (x 1.00)
3000K / 92 CRI (x 0.8)
3500K / 82 CRI (x 1.07)
4100K / 82 CRI (x 1.08)

Crisp White 3000K / 90 CRI (x0.85)*

Class A 3500K / 90 CRI (x0.96)*

* Lumens only, see IES file for candelas

Lens Multipliers:

Solite (x 0.92)
Clear (x 1.00)
Frosted (x 0.92)

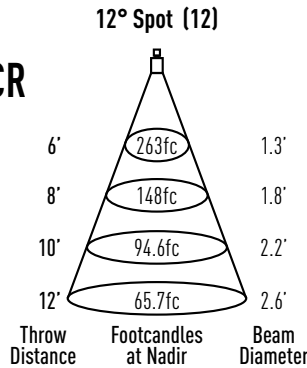

Watts: 10.7
Lumens: 640
LPW: 60
CCT: 3000K

Candelas at Nadir

Degree	CBCP
0°	9464
5°	5978
15°	410
25°	62
35°	13
45°	4

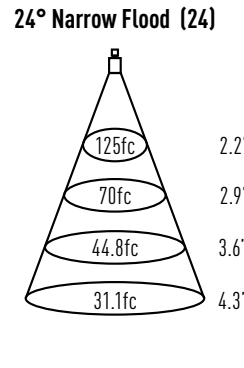

Watts: 10.7
Lumens: 640
LPW: 60
CCT: 3000K

Candelas at Nadir

Degree	CBCP
0°	4482
5°	3867
15°	877
25°	69
35°	10
45°	4

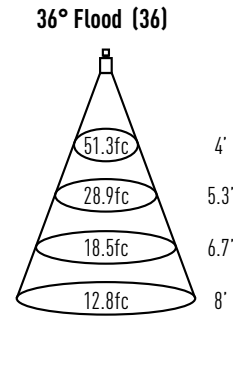

Watts: 10.7
Lumens: 739
LPW: 69
CCT: 3000K

Candelas at Nadir

Degree	CBCP
0°	1847
5°	1794
15°	1242
25°	373
35°	65
45°	5

MXDRTRL1 / MXT-RTRD308L1-CR

Report #: L041500702 (12)
L051500704 (24)
L051500706 (36)

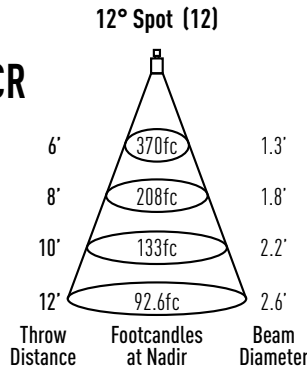

Watts: 15.1
Lumens: 902
LPW: 60
CCT: 3000K

Candelas at Nadir

Degree	CBCP
0°	13329
5°	8420
15°	578
25°	88
35°	19
45°	6

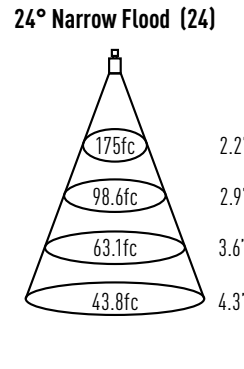

Watts: 15.1
Lumens: 902
LPW: 60
CCT: 3000K

Candelas at Nadir

Degree	CBCP
0°	6313
5°	5446
15°	1236
25°	97
35°	14
45°	6

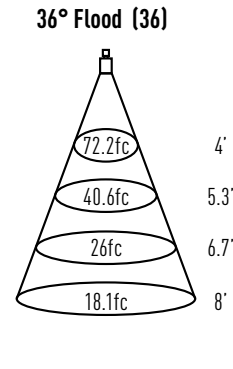

Watts: 15.2
Lumens: 1041
LPW: 69
CCT: 3000K

Candelas at Nadir

Degree	CBCP
0°	2601
5°	2526
15°	1750
25°	526
35°	92
45°	7

DIMMING COMPATIBILITY

JOB NAME		CATALOG NUMBER	
NOTES		TYPE	

0-10V DIMMING (10% Dimming, eldoLED 1%, eldoLED 0.1%)

- 120V/277V
- Dims down to 10% light output
- Consult dimming manufacturer for installation instructions and power packs

COMPATIBLE DIMMERS

Manufacturer	Part Number(s)
HUNT	PS-010-IV-120V, PS-010-WH-120V, PS-010-3W-IV-120, PS-010-3W-WH-120V, PS-010-IV-277V, PS-010-WH-277V, PS-010-3W-IV-277V, PS-010-3W-WH-277V, FD-010: PS-IFC-010-IV, PS-IFC-010-WH-120/277V, FD-010: PS-IFC-010-3W-IV, PS-IFC-010-3W-WH-120/277V, FD-010-120V, FD-010-277V
Leviton	Leviton Centura Fluorescent Control System, IllumaTech™ IP7 Series, DPSPE-212
Lightolier	ZP600FAM120, MP1500FAM120, V2000FAMU
Lithonia	LEQ BC, LEQ LVBC, SLD LVBC, SQ1DC
Lutron	DVTV, NTFTV
Synergy	ISD BC 120/277

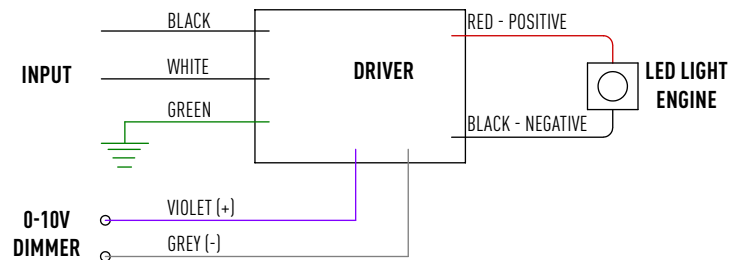

LUTRON ECOSYSTEM® DIMMING

- 120V or 277V
- Dims down to less than 1% or 5% light output
- Consult dimming manufacturer for installation instructions

COMPATIBLE DIMMERS

Product	Part Number(s)
EcoSystem	CS-1L-WM, CS-2L-WM, CS-1L-CM, CS-2L-CM, EcoSystem ESN, Grafik Eye QS with EcoSystem, Quantum

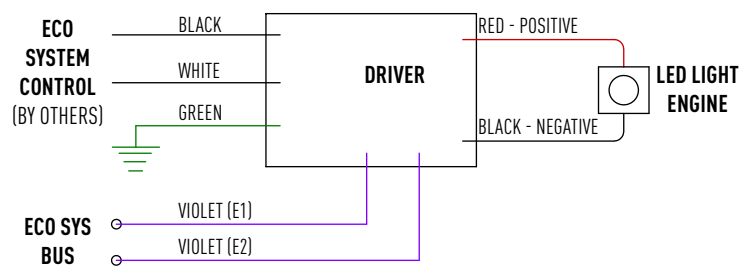

LUTRON HI-LUME® DIMMING

- 120V or 277V
- Dims down to less than 1% light output
- Consult dimming manufacturer for installation instructions

COMPATIBLE DIMMERS

Product	Part Number(s)
NovaT	NTF-10, NTF-103P, NTF-103P-277, NTF-10-277
Nova	NF-10, NF-103P, NF-103P-277, NF-10-277
Vareo	VF-10
Skylark	SF-10P, SF-12P-277, SF-12P-277-3, SF-103P
Diva	DVF-103, DVF-103P-277, DVSCF-103P, DVSCF-103P-277
Ariadni	AYF-103P, AYF-103P-277
Vierti	VTF-6AM
Maestro	MAF-6AM, MAF-6AM-277, MSCF-6AM, MCSF-6AM-277
Maestro Wireless	MRF2-F6AN-DV
Spacer System	SPSF-6A, SPSF-6A-277, SPSF-6AM, SPSF-6AM-277
Lyneo	LXF-103PL, LXF-103PL-277
Radio RA 2	RRD-F6AN-DV
HomeWorks QS	HQRD-F6AN-DV

