

FINELITE

LED T8 Muro-Square Technical Sheet

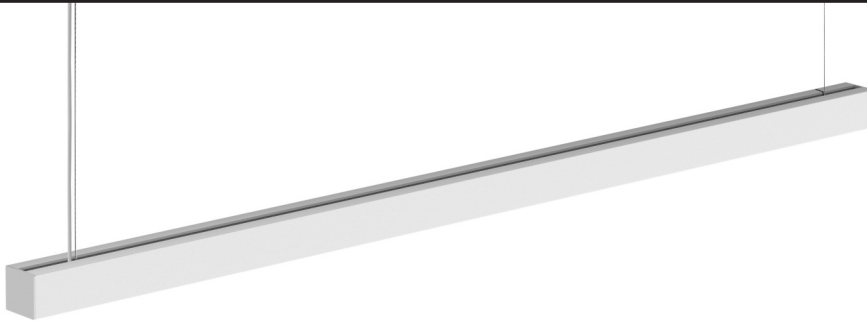

Date

Project

Type

Comments

Signal White is standard finish

DESCRIPTION

Muro-Square is a slim LED accent luminaire delivering excellent illumination of vertical surfaces for interior applications. Advanced LED T8 module design makes Muro a powerful solution for highlighting your best vertical features efficiently.

DIMENSIONS

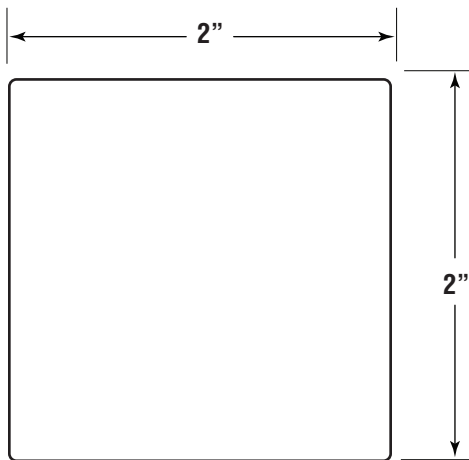

Actual Size



LED MODULE

Muro utilizes an optimized LED T8 module with integral driver that is powered directly by standard 120V-277V. LED and driver module can be replaced as easily as a standard fluorescent lamp at end of useful life.

FULLY ADJUSTABLE TOP MOUNT CABLE GRIPPER

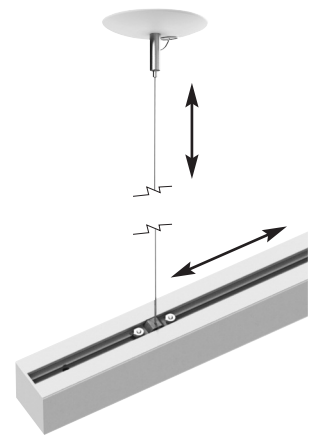

ADJUSTABLE MOUNTING:

Mounting points adjust along the entire length of the luminaire for added installation flexibility. Standard with fully adjustable cables.

ORDERING GUIDE

Sample Number: MU-S - 16' - LED T8 - 3500K - SC - 277 - FA - FE

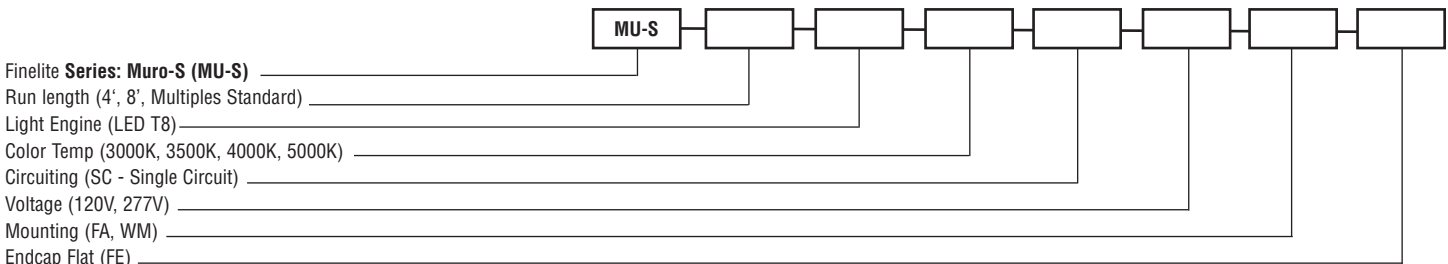

FINELITE

LED T8 Muro-Square Technical Sheet

PHOTOMETRY

Efficacy: 81.7 lumen per watt
 Total luminaire output: 1470.8 lumens (367.7 lumens/foot)
 18 watts (4.5 watts/foot)
 Peak Candela Value: 510 @ 55°
 CCT: 4000K
 Source Report ITL 69522
 (Family Correlation)

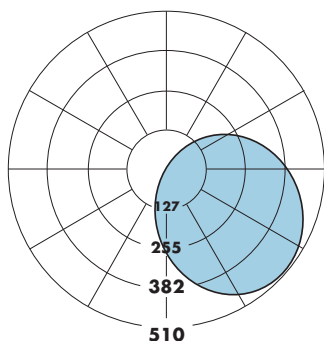
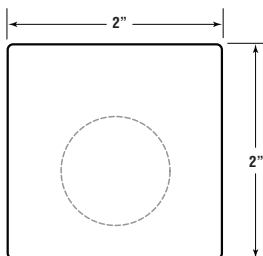

CANDLEPOWER SUMMARY						
	0	45.0	90.0	135.0	180.0	Flux
0	267	267	267	267	267	
5	320	308	267	220	197	23
15	393	356	257	138	92	70
25	449	389	236	59	23	106
35	487	404	208	2	0	135
45	506	404	174	32	0	158
55	510	390	133	0	0	171
65	494	363	86	0	0	172
75	457	323	41	0	0	160
85	413	276	6	0	0	138
90	344	224	0	0	0	
95	367	233	0	0	0	114
105	306	185	0	0	0	89
115	216	124	0	0	0	64
125	183	94	0	0	0	40
135	118	51	0	0	0	20
145	59	17	0	0	0	7
155	10	0	0	0	0	1
165	0	0	0	0	0	0
175	0	0	0	0	0	0
180	0	0	0	0	0	0

RUN LENGTH (Independent Pendant Luminaires*)

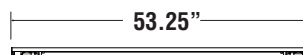

4ft Nominal Length

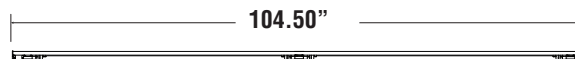

8ft Nominal Length

Note: Overall lengths include 0.125" thick at endcaps on each
 * Add 3.75" to lengths above for stem mounting.

PLUG TOGETHER WIRING

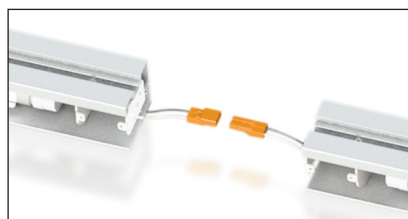

WALL MOUNT OPTION (STEM MOUNTING)

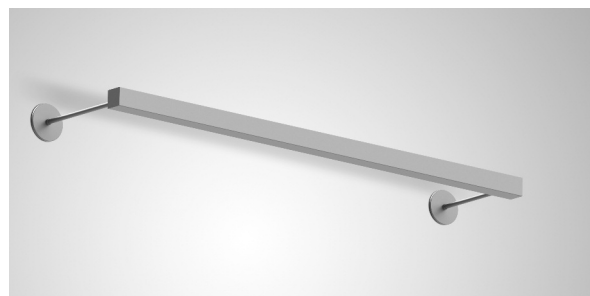

	Lumen Output Per Foot			
	3000K*	3500K*	4000K*	5000K*
Total Lumens Per Foot	349	349.3	367.7	367.7
Total Watts Per Foot	5	4.5	4.5	4.5
Efficacy (LPW)	78	77.6	81.7	81.7

* Family Correlation

SPECIFICATIONS

CONSTRUCTION: 6063-T6 extruded aluminum body with plug-together wiring standard. Brackets constructed of 16 gauge steel.

ENDCAPS: (FE) Flat endcap, 10 GA steel endcap 0.125" at each end.

REFLECTORS: Reflector is die-formed 25-gauge Alanod 8516GP semi-specular aluminum with 94% high reflectance finish.

ELECTRICAL: 120V or 277V prewired. Fixture and electrical components are ETL listed and ETL labeled.

FEED: 18 gauge straight cord standard.

LIGHT ENGINE: See chart for lumens output. LED T8 module with integrated internal driver.

MOUNTING: (FA) 50" fully adjustable aircraft cable standard with safety stop. Contact factory for additional lengths up to 150". Flexible mounting bracket adjusts along the length of the luminaire to accommodate existing mounting points. Optional: (WM) Wall Mounted Stem bracket mounts directly to wall j-box, extends fixture 18" from wall. Other lengths available. Consult factory.

SUPPORT CABLES: Plated steel cable and hardware.

FINISHES: Finelite Signal White powder coat finish standard. Optional adds: Custom color available for housing and endcaps. Contact factory.

LENGTHS: 4' and 8' section lengths can be combined to make longer runs. Contact factory for additional lengths.

LABELS: Fixture and electrical components are ETL listed conforming to UL 1598 in the U.S.A., and Canada; ETL listed to certified CAN/CSA C22.2 No. 250.0. Fixtures will bear ETL labels.

WEIGHT: Fixture weight = 0.6 lb./ft.