

FINELITE High Performance 2" Aperture (HP-2) - Wall Mount Direct



Date

Project

Type

Comments

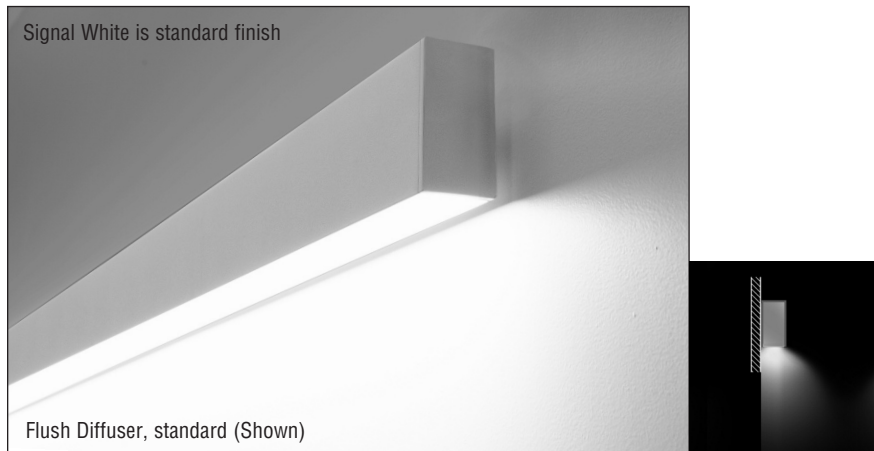

DESCRIPTION

High Performance 2" Aperture Wall Mount Direct (HP-2 WM D) is a patented, linear LED luminaire that offers many aesthetic options including Flush, Bottom Glow™, 1" Drop Down Lens, White Cross Blade Baffle, Hollowed Ellipse Louver, Hex Louver, and Regressed diffuser options for the downlight. HP-2 WM D delivers excellent performance using an advanced optical design and mid-power LEDs to achieve 90% of initial light output at 100,000+ hours.

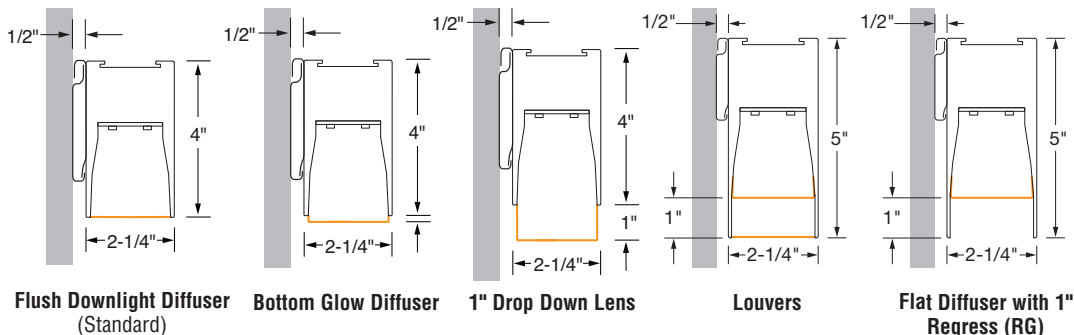

MOUNTING BRACKET (MB)
Luminaire hangs securely from mounting brackets fastened directly to wall.

AESTHETIC SOLUTIONS

Offering multiple diffuser options with Flush, Bottom Glow, 1" Drop Down Lens, Louvers, and Regressed for a desired aesthetic.

ORDERING GUIDE: Sample Number: HP-2 WM D - 32' - H - 835 - F - 120V - MB - FE - SC - OBO

Finelite HP-2 WM D	<input type="checkbox"/>
HP-2 WM D RG	<input type="checkbox"/>
Length (Minimum 2', increments accurate to 1/16" (± 1/32"), standard)	<input type="text"/>
Light Output (S - Standard, B - Boosted Standard, H - High, V - Very High)	<input type="text"/>
LED CRI/CCT (830 - 80 CRI min, 3000K 930 - 90 CRI min, 3000K;	<input type="text"/>
835 - 80 CRI min, 3500K 935 - 90 CRI min, 3500K;	<input type="text"/>
840 - 80 CRI min, 4000K 940 - 90 CRI min, 4000K)	<input type="text"/>
Downlight Option (F ¹ - Flush (standard), BG ¹ - Bottom Glow, DL ¹ - 1" Drop Down Lens, RG-D ² - Flat Diffuser with 1" Regressed, RG-WCB ^{2,3} - White Cross Blade Baffle, RG-LHE ^{2,3} - Hollowed Ellipse Louver, RG-LHC ^{2,3} - Hex Louver)	<input type="text"/>
Voltage (120V , 277V , 347V)	<input type="text"/>
Mounting (MB - Mounting Bracket)	<input type="text"/>
Endcap (FE - Flat Endcap, DE ⁴ - 1" Drop Down Lens Illuminated Endcap, OE ⁵ - Open Endcap)	<input type="text"/>
Circuiting ⁶ (SC - Single Circuit)	<input type="text"/>
Integrated Sensor ⁷ (OBO - Occupancy Sensor, OBD - Daylight)	<input type="text"/>

¹ Available for HP-2 Wall Mount Direct (HP-2 WM D) only
² Available for HP-2 Wall Mount Direct Regressed (HP-2 WM D RG) only
³ Available in 1" increments
⁴ Available for 1" Drop Down Lens (DL) downlight option only
⁵ Available with Hollowed Ellipse Louver (LHE) only
⁶ Contact factory for switching options.
⁷ Available with Flush (F), Bottom Glow (BG), White Cross Blade Baffle (WCB), and Regressed (RG) downlight diffusers

Protected by one or more US Patents: 8915613; D702,391; D702,390; D700,732; D727,554 S; D727,550 S, D727,551 S

A brand of Legrand

Finelite, Inc. • 30500 Whipple Road • Union City, CA 94587-1530 • (510) 441-1100 • Fax: (510) 441-1510 • www.finelite.com

FINELITE High Performance 2" Aperture (HP-2) - Wall Mount Direct

AESTHETIC OPTIONS

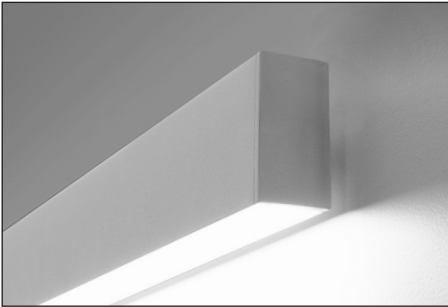

Flush Diffuser (F)

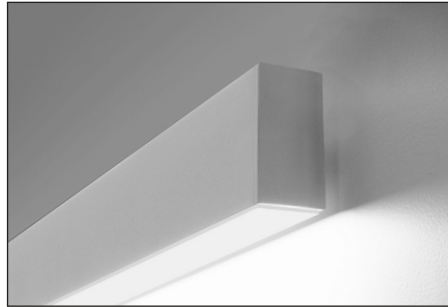

Bottom Glow Diffuser (BG)

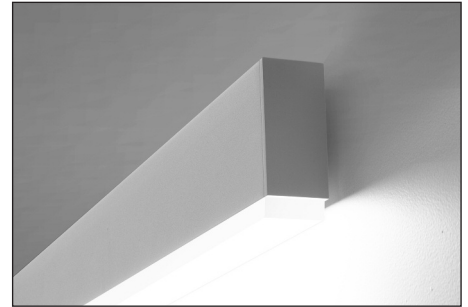

1" Drop Down Lens (DL)

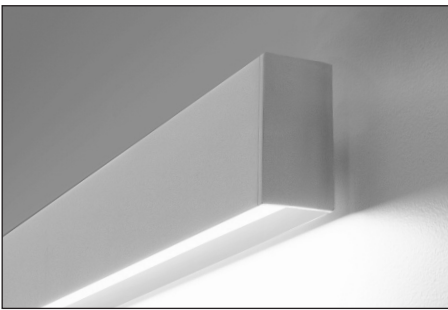

Flat diffuser with 1" Regress (RG)

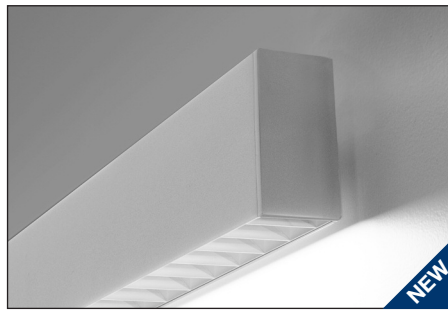

White Cross Blade Baffle (RG-WCB)

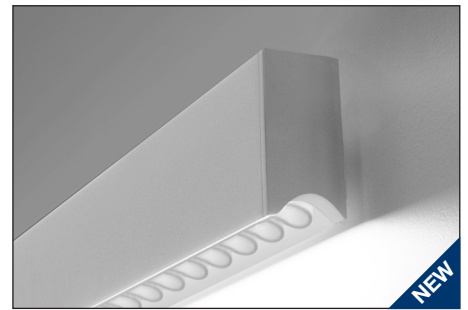

Hollowed Ellipse Louver (RG-LHE)

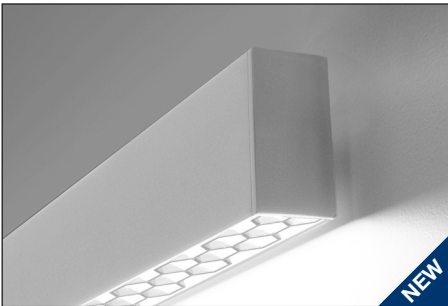

Hex Louver (RG-LHC)

FINELITE High Performance 2" Aperture (HP-2) - Wall Mount Direct

PHOTOMETRY

DOWNLIGHT: FLUSH DIFFUSER

HP-2-D-V-835

Very High Output - 4' Luminaire

Efficacy: 87 lumens per watt

Total luminaire output: 3215 lumens (804 lumens/foot)

36.9 watts (9.2 watts/foot)

Peak Candela Value: 1334 @ 0°

CCT: 3500K

ITL LM79 Report 85136

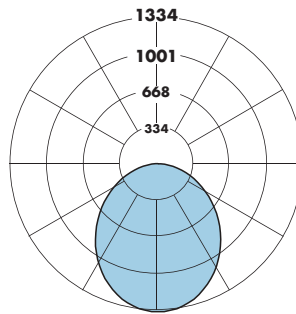

CANDELA DISTRIBUTION						
	0.0	22.5	45	67.5	90	Flux
0	1334	1334	1334	1334	1334	
5	1327	1326	1326	1325	1324	126
15	1263	1252	1251	1244	1236	352
25	1133	1117	1109	1088	1075	508
35	958	942	923	896	887	576
45	762	747	725	697	686	558
55	563	551	532	509	500	475
65	374	365	351	337	331	349
75	206	201	195	188	184	207
85	62	61	59	57	57	66
90	0	0	0	0	0	

Total Light Output, 3500K, 80 CRI (Lumens) - 4' Luminaire			
S*	B*	H*	V**
1316	1655	2501	3215

Light Output, 3500K, 80 CRI (Lumens Per Foot)			
S*	B*	H*	V**
329.0	414	625	804

Power, 3500K, 80 CRI (Watts Per Foot)			
S*	B*	H*	V**
3.6	4.6	7.1	9.2

Efficacy, 3500K, 80 CRI (Lumens Per Watt)			
S*	B*	H*	V**
91	90	88	87

Lumen Adjustment Factors - 80 CRI	
3000K	0.985
3500K	1.000
4000K	1.032

Lumen Adjustment Factors - 90 CRI	
3000K	0.746
3500K	0.760
4000K	0.789

Apply a lumen adjustment factor to calculate lumens for the desired CCT and CRI.

SAMPLE LUMEN ADJUSTMENT CALCULATION

High Output (H), 4000K, 90 CRI

Lumen Adjustment Factor = 0.789

$$\text{Total Light Output} = 2501 \text{ lm} \times 0.789 = 1973 \text{ lm}$$

$$\text{Total Light Output per Foot} = 625 \text{ lm/ft} \times 0.789 = 493 \text{ lm/ft}$$

$$\text{watts/foot} = 7.1 \text{ W/ft}$$

$$\text{Efficacy} = \frac{493 \frac{\text{lm}}{\text{ft}}}{7.1 \frac{\text{W}}{\text{ft}}} = 69.4 \text{ lm/W}$$

S - Standard Output, B - Boosted Standard Output, H - High Output, V - Very High Output

* Family Correlation based on 4' luminaire 3500K Very High Output (V) test - 120V.

** Based on ITL report: 85136

FINELITE High Performance 2" Aperture (HP-2) - Wall Mount Direct

PHOTOMETRY

DOWNLIGHT: 1" DROP DOWN LENS

HP-2-D-V-835-DL

Very High Output - 4' Luminaire

Efficacy: 99 lumens per watt

Total luminaire output: 3637 lumens (909 lumens/foot)

36.8 watts (9.2 watts/foot)

CCT: 3500K

CRI: 80

ITL LM79 Report 90630

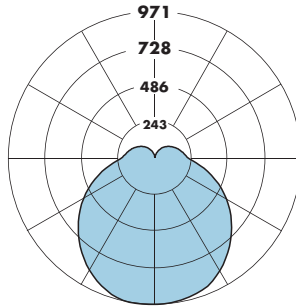

CANDELA DISTRIBUTION

	0.0	22.5	45	67.5	90	Flux
0	969	969	969	969	969	
5	964	965	967	970	971	92
15	921	925	944	955	957	265
25	833	848	880	895	900	402
35	718	745	788	808	814	486
45	586	627	677	705	714	513
55	445	497	556	591	603	485
65	301	362	427	468	483	409
75	159	226	298	344	361	299
85	43	112	187	235	252	189
90	11	78	150	198	213	
95	10	73	141	185	199	137
105	9	61	123	162	175	116
115	7	50	105	139	151	92
125	5	38	85	115	125	68
135	3	26	64	90	99	45
145	2	15	42	65	72	25
155	1	7	22	38	44	11
165	1	2	8	13	18	2
175	0	0	0	0	0	0
180	0	0	0	0	0	0

Total Light Output, 3500K, 80 CRI (Lumens) - 4' Luminaire

S*	B*	H*	V**
1489	1872	2829	3637

Lumen Adjustment Factors - 80 CRI

3000K	0.985
3500K	1.000
4000K	1.032

Light Output, 3500K, 80 CRI (Lumens Per Foot)

S*	B*	H*	V**
372	468	707	909

Lumen Adjustment Factors - 90 CRI

3000K	0.746
3500K	0.760
4000K	0.789

Power, 3500K, 80 CRI (Watts Per Foot)

S*	B*	H*	V**
3.6	4.6	7.1	9.2

Apply a lumen adjustment factor to calculate lumens for the desired CCT and CRI.

Efficacy, 3500K, 80 CRI (Lumens Per Watt)

S*	B*	H*	V**
103	102	100	99

SAMPLE LUMEN ADJUSTMENT CALCULATION

High Output (H), 4000K, 90 CRI

Lumen Adjustment Factor = 0.789

$$\text{Total Light Output} = 2829 \text{ lm} \times 0.789 = 2232 \text{ lm}$$

$$\text{Total Light Output per Foot} = 707 \text{ lm/ft} \times 0.789 = 558 \text{ lm/ft}$$

$$\text{watts/foot} = 7.1 \text{ W/ft}$$

$$\text{Efficacy} = \frac{558 \frac{\text{lm}}{\text{ft}}}{7.1 \frac{\text{W}}{\text{ft}}} = 79 \text{ lm/W}$$

S - Standard Output, B - Boosted Standard Output, H - High Output, V - Very High Output

* Family Correlation based on 4' luminaire 3500K Very High Output (V) test - 120V.

** Based on ITL report: 90630

FINELITE High Performance 2" Aperture (HP-2) - Wall Mount Direct

PHOTOMETRY

DOWNLIGHT: REGRESSED DIFFUSER

HP-2-D-RG-V-835

Very High Output - 4' Luminaire

Efficacy: 79 lumens per watt

Total luminaire output: 2887 lumens (722 lumens/foot)

36.7 watts (9.2 watts/foot)

CCT: 3500K

CRI: 80

ITL LM79 Report 90350

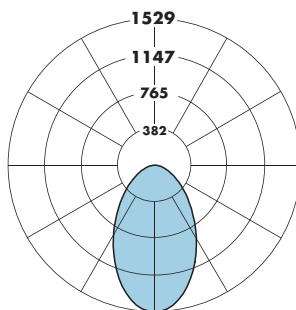

CANDELA DISTRIBUTION

	0.0	22.5	45	67.5	90	Flux
0	1529	1529	1529	1529	1529	
5	1520	1518	1513	1507	1504	143
15	1443	1412	1370	1327	1309	385
25	1293	1224	1131	1049	1017	523
35	1086	993	862	757	722	550
45	855	749	608	511	482	490
55	624	516	392	322	305	380
65	407	311	219	178	171	249
75	212	141	103	95	94	131
85	57	32	28	26	26	36
90	0	0	0	0	0	

Total Light Output, 3500K, 80 CRI (Lumens) - 4' Luminaire

S*	B*	H*	V**
1182	1486	2245	2887

Light Output, 3500K, 80 CRI (Lumens Per Foot)

S*	B*	H*	V**
295	371	561	722

Power, 3500K, 80 CRI (Watts Per Foot)

S*	B*	H*	V**
3.6	4.6	7.0	9.2

Efficacy, 3500K, 80 CRI (Lumens Per Watt)

S*	B*	H*	V**
82	81	80	79

S - Standard Output, B - Boosted Standard Output, H - High Output, V - Very High Output

* Family Correlation based on 4' luminaire 3500K Very High Output (V) test - 120V.

** Based on ITL report: 90350

Lumen Adjustment Factors - 80 CRI

3000K	0.985
3500K	1.000
4000K	1.032

Lumen Adjustment Factors - 90 CRI

3000K	0.746
3500K	0.760
4000K	0.789

Apply a lumen adjustment factor to calculate lumens for the desired CCT and CRI.

SAMPLE LUMEN ADJUSTMENT CALCULATION

High Output (H), 4000K, 90 CRI

Lumen Adjustment Factor = 0.789

$$\text{Total Light Output} = 2245 \text{ lm} \times 0.789 = 1771 \text{ lm}$$

$$\text{Total Light Output per Foot} = 561 \text{ lm/ft} \times 0.789 = 443 \text{ lm/ft}$$

$$\text{watts/foot} = 7.0 \text{ W/ft}$$

$$\text{Efficacy} = \frac{443 \frac{\text{lm}}{\text{ft}}}{7.0 \frac{\text{W}}{\text{ft}}} = 63 \text{ lm/W}$$

FINELITE High Performance 2" Aperture (HP-2) - Wall Mount Direct

PHOTOMETRY

DOWNLIGHT: WHITE CROSS BLADE BAFFLE

HP-2-D-RG-V-835-WCB

Very High Output - 4' Luminaire

Efficacy: 59 lumens per watt

Total luminaire output: 2169 lumens (542 lumens/foot)
36.5 watts (9.1 watts/foot)

Peak Candela Value: 1276 @ 0°

CCT: 3500K

CRI: 80

ITL LM79 Report 91551

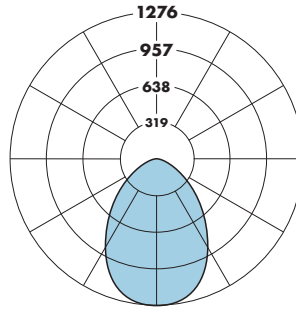

CANDELA DISTRIBUTION						
	0.0	22.5	45.0	67.5	90.0	Flux
0	1276	1276	1276	1276	1276	
5	1245	1250	1259	1269	1273	119
15	1076	1088	1135	1186	1209	319
25	850	869	931	982	1019	426
35	609	633	680	735	783	428
45	371	395	452	506	547	351
55	250	251	270	307	323	251
65	156	156	163	169	176	163
75	81	82	84	85	86	89
85	21	21	20	20	20	24
90	0	0	0	0	0	

Total Light Output, 3500K, 80 CRI (Lumens) - 4' Luminaire			
S*	B*	H*	V**
888	1116	1687	2169

Light Output, 3500K, 80 CRI (Lumens Per Foot)			
S*	B*	H*	V**
222	279	422	542

Power, 3500K, 80 CRI (Watts Per Foot)			
S*	B*	H*	V**
3.6	4.5	7.0	9.1

Efficacy, 3500K, 80 CRI (Lumens Per Watt)			
S*	B*	H*	V**
62	61	60	59

S - Standard Output, **B** - Boosted Standard Output, **H** - High Output, **V** - Very High Output

* Family Correlation based on 4' luminaire 3500K Very High Output (V) test - 120V.

** Based on ITL report: 91551

Lumen Adjustment Factors - 80 CRI	
3000K	0.985
3500K	1.000
4000K	1.032

Lumen Adjustment Factors - 90 CRI	
3000K	0.746
3500K	0.760
4000K	0.789

Apply a lumen adjustment factor to calculate lumens for the desired CCT and CRI.

SAMPLE LUMEN ADJUSTMENT CALCULATION

High Output (H), 4000K, 90 CRI

Lumen Adjustment Factor = 0.789

$$\text{Total Light Output} = 1687 \text{ lm} \times 0.789 = 1771 \text{ lm}$$

$$\text{Total Light Output per Foot} = 422 \text{ lm/ft} \times 0.789 = 333 \text{ lm/ft}$$

$$\text{watts/foot} = 7.0 \text{ W/ft}$$

$$\text{Efficacy} = \frac{333 \frac{\text{lm}}{\text{ft}}}{7.0 \frac{\text{W}}{\text{ft}}} = 48 \text{ lm/W}$$



FINELITE High Performance 2" Aperture (HP-2) - Wall Mount Direct

SPECIFICATIONS

CONSTRUCTION: Precision-cut 6061-T6 extruded aluminum body. Internal joiner system, plug-together wiring, standard.

ENDCAPS: Flat diecast aluminum endcaps add 1/4" to each end of luminaire. Drop Down Lens Illuminated Endcap (**DE**) includes diffuse element to continue luminance of drop lens. It is made of the same material as the drop lens. Open Endcap (**OE**) is for use with the Hollowed Ellipse Louver (**LHE**); following the curve of the louver.

MITERED CORNER¹: Illuminated 90° corners in a single plane, Flush downlight diffuser (standard), or White Cross Blade Baffle (optional). Custom angles are available (90° minimum on inside corners), contact factory. 90 degree corners not available with Hollowed Ellipse Louver (**LHE**) or Hex Louver (**LHC**).

REFLECTORS: Die-formed 24-gauge cold-rolled steel reflectors are finished in 96 LG high reflectance matte white powder coat paint.

DOWNLIGHT OPTION: 12' maximum diffuser length. Flush frost white snap-in diffuser standard, 73% transmissive, 99% diffusion. Internal secondary diffusers at corners ensure visually seamless, uniform, continuous illumination. Available with Flush (**F**), Bottom Glow (**BG**), 1" Drop Down Lens (**DL**), White Cross Blade Baffle (**WCB**), Hollowed Ellipse Louver (**LHE**), Hex Louver (**LHC**), and Regressed downlight diffusers (**RG**). 1" Drop Down Lens made of highly efficient acrylic. Available with a solid endcap or an endcap with a diffuse filler to continue the luminous aesthetic.

LIGHT OUTPUT: Four lumen packages available, Standard (**S**), Boosted Standard (**B**), High (**H**), and Very High (**V**). A separate chart summarizes lumen distribution and wattage. Light engines are replaceable.

LUMEN MAINTENANCE: 90% of initial light output (L90) at 100,000+ hours; 70% of initial light output (L70) at 200,000+ hours.

DRIVER: Replaceable 120V/277V and 347V Constant Current Reduction dimming driver standard. Can be wired dimming or non-dimming. 0-10V dimming controls with a range of 10%- 100%. Dimming to 1% available; consult factory. Driver is fully accessible from below the ceiling. Power Factor: ≥0.9. Total Harmonic Distortion (THD) <20%. Expected driver lifetime: 100,000 hours. Dali driver also available; Contact factory.

LUTRON DRIVER OPTIONS: **LUTES1** (Hi-lume 1% EcoSystem with Soft-On, Fade to Black dimming (LDE1 series)); **LUTES5** (5-Series 5% EcoSystem (LDE5 Series)), **LUT2W** (Hi-lume 1% 2-wire, 120V forward phase dimming (LTEA series)); Contact factory for availability of discontinued Lutron drivers, L3DA-3-wire and L3DA EcoSystem.

ELECTRICAL: Optional emergency to generator/inverter wiring, internal generator transfer switch, nightlight wiring, step-dimming driver, backup battery. Factory-choice low-profile backup battery available. 8' minimum luminaire length for low profile battery pack. Backup batteries deliver 1608 lumens. Half of a 4' section will be illuminated in emergency mode.

INTEGRATED SENSORS: Integrated PIR (Passive Infrared) occupancy and/or daylight sensors available with Flush, Bottom Glow, White Cross Blade Baffle, and Regressed downlight diffusers. Refer to Occupancy Sensor and Daylight Sensor tech sheets for more info.

MOUNTING: Luminaire hangs securely from mounting brackets fastened directly to the wall for easy installation. Luminaire hangs 1/2" from wall. Mounting bracket is concealed behind luminaire.

FINISHES: Finelite Signal White powder coat standard. Optional Adders: 185 RAL colors.

FEED: Standard with one 18-gauge/5-conductor single-circuit feed. 14-gauge feed used when luminaire current exceeds 5 amps. Optional 6' flex conduit whips available.

LENGTHS: Any length, 2-foot minimum, in increments down to 1/16" (± 1/32"). 12-foot maximum section length. Hollowed Ellipse Louver (**LHE**), Hex Louver (**LHC**), and White Cross Blade Baffle (**WCB**) are available in 1' increments.

LABELS: Fixture and electrical components are ETL-listed conforming to UL 1598 in the U.S.A. and CAN/CSA C22.2 No. 250.0 in Canada. In accordance with NEC Code 410.130 (G), this luminaire contains an internal driver disconnect. Damp Location. Finelite products use electronic components that are RoHS compliant, and the mechanical components of the luminaire have been verified to not knowingly contain any restricted substances listed per RoHS Directive 2011/65/EU.

WEIGHT: 2.3 lb/ft.

WARRANTY: 10-year performance-based warranty on all standard components. Optional accessories such as emergency battery packs are covered by their individual manufacturer warranties.

¹ White Cross Blade (WCB) is not available with custom angles. Available in 90 degrees only