



FINELITE

High Performance Recessed (HPR-LED) 1x4



HPR-LED Collection
2011 IES Progress
Report Selection



Date

Project

Type

Comments

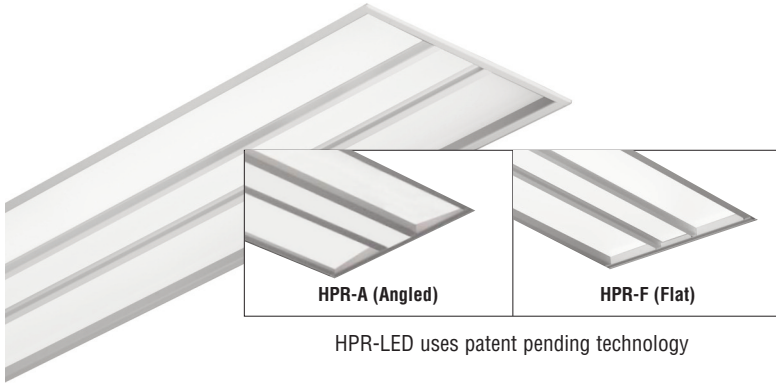

HPR-LED uses patent pending technology

DESCRIPTION

HPR-LED is a highly effective recessed luminaire delivering excellent visual comfort and outstanding performance for offices, schools, healthcare, and retail applications. Advanced optical designs make HPR-LED a powerful solution for low-ceiling applications and eliminate the shadows common to other LED recessed products. HPR-LED RoHS compliant.

[GET A QUOTE >](#)



GLARE-FREE ILLUMINATION:

A glare-free experience is attained with mid-powered LEDs properly distributed and paired with a precise diffuser to eliminate pixilation.



100% SERVICEABLE FROM BELOW:

The light engine and driver can be easily changed from below ceiling – and it's simple to install.

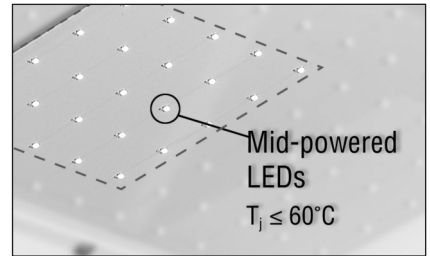

THERMAL MANAGEMENT:

Mid-powered LEDs let heat be fully dissipated without the need for additional heat sinks.

ORDERING GUIDE

Sample Number: HPR - A - 1x4 - DCO - LED - 4000K - 277V - SC - C1 - OBO - AR

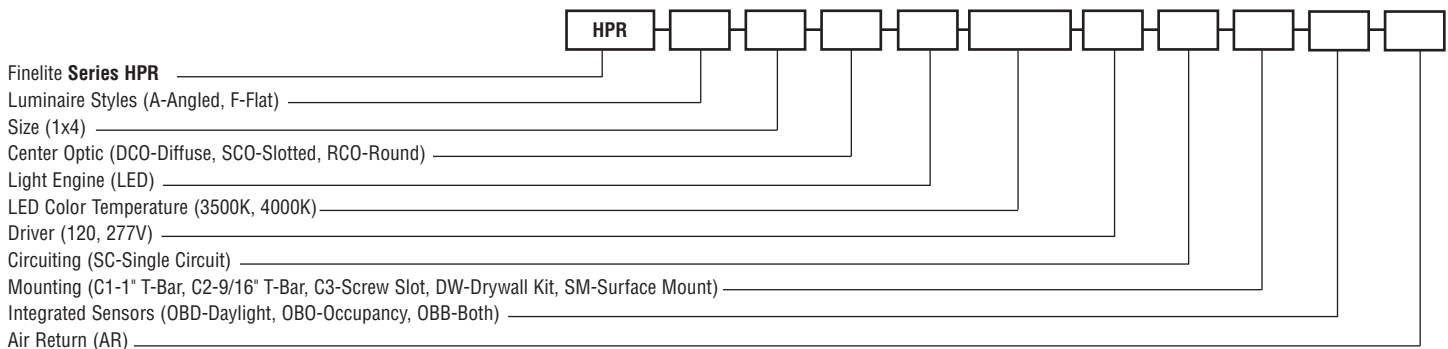

High Performance Recessed (HPR-LED) 1x4

PHOTOMETRY

HPR-LED-F DCO (1x4)
84.7 Lumens Per Watt
3167 Lumens/37 Watts
CRI:82
R9: 7
CCT: 4000K
ITL LM79 Report 70288

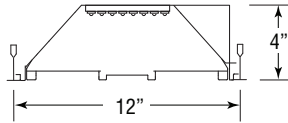

HPR-LED-F DCO (1x4)
74.5 Lumens Per Watt
2802 Lumens/38 Watts
CRI: 83
R9: 10
CCT: 3500K
ITL LM79 Report 70107

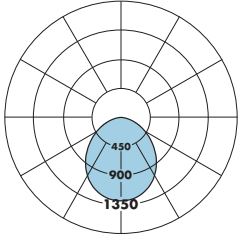
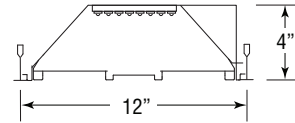

— Refer to www.finelite.com for additional photometry and product information.

CANDLEPOWER SUMMARY						
	0.0	22.5	45	67.5	ACROSS	Flux
0	1289	1289	1289	1289	1289	
5	1286	1286	1283	1278	1278	122
10	1264	1265	1264	1259	1259	
15	1228	1229	1228	1227	1226	346
20	1177	1178	1178	1178	1178	
25	1114	1117	1114	1116	1112	513
30	1036	1043	1036	1036	1029	
35	956	956	949	943	938	592
40	861	858	850	837	829	
45	762	758	742	725	719	573
50	656	657	636	621	603	
55	562	553	534	511	498	475
60	456	452	432	409	394	
65	361	355	334	311	300	331
70	266	268	242	228	215	
75	187	184	162	148	140	174
80	110	107	91	79	72	
85	48	42	29	25	23	41
90	0	0	0	0	0	

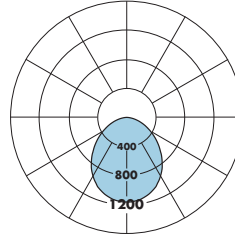

— Refer to www.finelite.com for additional photometry and product information.

CANDLEPOWER SUMMARY						
	0.0	22.5	45	67.5	ACROSS	Flux
0	1161	1161	1161	1161	1161	
5	1156	1157	1155	1150	1150	110
10	1134	1135	1137	1135	1135	
15	1098	1101	1104	1104	1105	311
20	1050	1055	1059	1059	1060	
25	991	998	998	1001	998	459
30	920	929	927	925	920	
35	844	849	847	836	833	526
40	757	761	752	740	732	
45	663	665	652	640	627	504
50	568	575	558	544	528	
55	482	482	464	448	439	415
60	393	391	374	357	347	
65	305	305	290	275	267	288
70	226	230	213	204	195	
75	153	159	143	135	128	154
80	93	95	82	74	69	
85	41	40	27	23	20	37
90	0	0	0	0	0	

SPECIFICATIONS

CONSTRUCTION: Fixture assembly constructed using die-formed 20-gauge cold-rolled steel housing and ends. All components are hard-tooled to tolerances of 0.010". Ballast compartment is accessed from below. Optical system retained using hinged door frame assembly to provide easy access to ballast compartment and for re-lamping from below without the need of tools. Seismic brackets are integrated into the fixture assembly. Additional wire entrances are positioned on the ends of the housing to allow easy wiring access for the installer.

REFLECTORS: Die-formed 20-gauge cold-rolled steel reflectors are finished in 96 LG high reflectance matte white powder coat paint.

OPTICAL SYSTEM: Optical system components include diffuser panels and a center optic element held in place with a frame constructed from die-formed cold-rolled steel. The diffusers are UV-stabilized and impact-resistant frosted virgin acrylic, 0.120" thick. They are either angled toward the center optic or parallel to the ceiling plane.

Available options for the center optic elements:

Diffuse Center Optic: UV-stabilized and impact-resistant frosted virgin acrylic.

Slotted Center Optic: Die-formed cold-rolled steel panel with 1/16" x 1/2" rectangular hole pattern. Virgin acrylic overlay.

Round Center Optic: Die-formed cold-rolled steel panel with precision-punched 3/32" round hole pattern arranged in staggered formation. Virgin acrylic overlay.

LIGHT ENGINE: 1x4 HPR-LED (3500K) delivers 2802 lumens at 37.6W and 1x4 HPR-LED (4000K) delivers 3167 lumens at 37.4W. Light engine is made up of high performance mid-powered LEDs and is designed to distribute heat properly to maximize the life of the LED. LED color temperature: 3500K or 4000K. CRI: 82 (4000K), CRI: 83 (3500K), R9: 7 (4000K), R9: 10 (3500K).

DRIVER: High performance LED driver. Driver is fully accessible from below the ceiling. *120/277v. Power Factor = 94.8% (4000K), 95% (3500K). Contact factory for Emergency Battery backups. Total harmonic distortion (THD) <20%. Input current: 0.33A @ 120VAC, and 0.16A @ 277VAC.

*Driver can be wired as dimming or non-dimming. Dimming is compatible with 0-10v controls with a range of 100-20%.

ELECTRICAL: Fixtures and electrical components are ETL listed conforming to UL1598 in the USA, and Canada and ETL listed certified to CAN/CSA C22.2 No. 250.0. In accordance with NEC code 410.73 (G) this luminaire

contains an internal driver disconnect. Optional Chicago Plenum available. Contact factory.



INTEGRATED SENSORS: Refer to Occupancy Sensor and Daylight Sensor tech sheets for more info.

MOUNTING: Standard flange design works with most lay-in ceiling types. Integral pryout tabs secure luminaire to ceiling grid from above. Fixture offers tie-in locations for tie-wire on all corners. Consult local code for appropriate tie-wire recommendations. Drywall Kit available. Surface mount version available; refer to separate tech sheet.

AIR RETURN: Contact factory for more information

FEED: 18-gauge wire standard.

FINISH: Housing and door assembly painted with 96 LG high reflectance matte white powder coat paint. Available in matte white only.

WEIGHT: Maximum weight: 1x4 - 25 lbs.

WARRANTY: HPR-LED comes standard with a 10-year, warranty on all components.

DLC Qualified: HPR-LED 1x4 with Diffuse Center Optic (DCO) is qualified under the DesignLights™ Consortium program.