



WALL | ARM

Huntington 3

Brilliant by Design™, minimalistic aesthetic combined with our innovative Microstructure EdgeTech Optics (MEO)™ will bring your vision to light. The innovative MEO™ design utilizes high efficiency Microstructure Lenses and Light Guide Plates for high optical extraction and precise light management.

FEATURES

- Innovative Microstructure EdgeTech Optics™ delivers unparalleled optic control and exceptional performance with seamless illumination and uniformity. Specify Batwing, Glare Control, Diffused (Lambertian), or Wall Wash Optics.
- MEO™ allows for minimalistic 3" Aperture fixtures with extremely low profiles.
- Individual fixture lengths and seamless continuous rows with no lens breaks up to 400 feet.
- Innovative Toolless "Push to Eject" System allows for easy installation and serviceability.
- No visible fasteners.
- Custom powder coat and anodized finishes.
- Specified Lumen Outputs (SLO) available.
- Proudly crafted in Huntington Beach, CA - USA.

HUNTINGTON 3 LINEUP

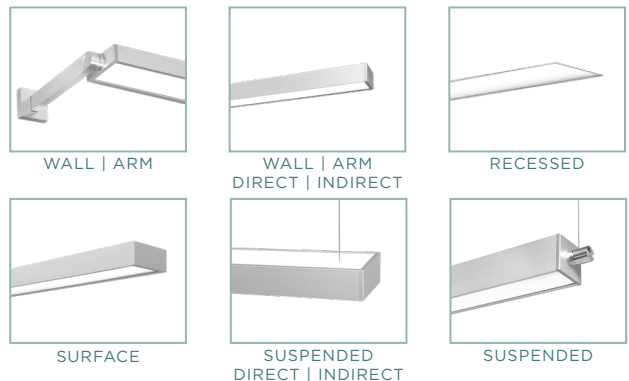

PERFORMANCE OVERVIEW

| 4' Huntington 3 Direct - 3500K 80CRI | | | | |
|--------------------------------------|----------|-------------|-----------|------------------|
| Lumen Output | LL (Low) | ML (Medium) | HL (High) | SLO* (Specified) |
| Delivered Lumens | 896 | 2208 | 4352 | 896-6852 |
| Consumed Wattage | 7 | 18 | 38 | 7.3 - 65.6 |
| Efficacy (lm/W) | 122 | 121 | 115 | 105-122 |
| SDCM | 3 | 3 | 3 | 3 |

*Specified Lumen Output (SLO) available in customizable lumen configurations (896 lm - 6852 lm). See SLO Configurator at ExtantLighting.com



Ordering Information

PROJECT _____ TYPE _____
 PRODUCT _____ QTY _____

| Product Family | Driver Location | Mounting Direction | Length | Lumen Output |
|--|--|---|---|---|
| HTG-3W Huntington Series 3" Aperture (Wall Mount) | <input type="checkbox"/> TD Integral Driver | <input type="checkbox"/> DT Direct | <input type="checkbox"/> _____* Specify length in 1 foot increments <input type="checkbox"/> L_x_x L Pattern <input type="checkbox"/> CP Custom Pattern *Minimum Integral Driver length is 2'. Minimum Remote or In Canopy Driver can be shorter, consult factory. *Custom length fixtures can be ordered in 3" increments. *Any length over 8' requires multiple fixture segments. **Patterns are not available on Rotational Arm Mount fixtures | <input type="checkbox"/> DLL Low (224 l/ft @ 1.84 W)* <input type="checkbox"/> |
| | <input type="checkbox"/> RD Remote Driver | <input type="checkbox"/> UT Indirect Note: Leave blank if Wall Mounted Rotational Arm (WR) selected in MOUNTING | | <input type="checkbox"/> DML Medium (552 l/ft @ 4.55 W)* <input type="checkbox"/> |
| | | | | <input type="checkbox"/> DHL High (1080 l/ft @ 9.46 W)* <input type="checkbox"/> SLO-xx **Specified Lumen Output available. *Delivered lumen output & consumed wattage based on "MEODF 835" (80 CRI - 3500K). See SLO Configurator for alternate outputs. |

| Optics | Color Temp | Voltage | Driver |
|--|---|--|---|
| <u>MEO</u> <input type="checkbox"/> MEODF Diffusing <input type="checkbox"/> MEOBW Batwing <input type="checkbox"/> MEOGC Glare Control <input type="checkbox"/> MEOWW Wall Wash <u>PRO*</u> <input type="checkbox"/> PROAY Asymmetric <input type="checkbox"/> PROWD Wide <input type="checkbox"/> PRONR Narrow *PRO Optics are only available in 90+ CRI *PRO Optics are not a diffused light source. LED pixelation will be seen with this optic choice. See page 4 for details. | <u>80+ CRI</u> <input type="checkbox"/> 830 3000K <input type="checkbox"/> 835 3500K <input type="checkbox"/> 840 4000K <u>90+ CRI</u> <input type="checkbox"/> 927 2700K <input type="checkbox"/> 930 3000K <input type="checkbox"/> 935 3500K <input type="checkbox"/> 940 4000K <input type="checkbox"/> XX Optional Color Temp & CRI Available | <input type="checkbox"/> VU 120V-277V <input type="checkbox"/> V3 347V <input type="checkbox"/> V1 120V (for DL2 Driver only) | <input type="checkbox"/> D'__ 1% 0-10V <input type="checkbox"/> DN NON DIM <input type="checkbox"/> DL5 Lutron 5-Series EcoSystem <input type="checkbox"/> DL1 Lutron Hi-Lume 1% EcoSystem <input type="checkbox"/> DL2 Lutron Hi-Lume 1% 2-wire (120V only) <input type="checkbox"/> DE* .1% 0-10V <input type="checkbox"/> DD1 1% DALI <input type="checkbox"/> DDE .1% DALI <input type="checkbox"/> XX Other (Please Specify) *Dim to Off available. Please Specify "-OFF" next to driver option if required. *1% minimum dimming level and other custom dimming levels and settings available. Consult factory. |

| Finish | Options | Mounting | Arm Length* | Coverplate* |
|--|--|---|---|--|
| <input type="checkbox"/> SA* Silver Anodized <input type="checkbox"/> WP* Matte White <input type="checkbox"/> BP* Matte Black <input type="checkbox"/> CC* Custom *When above finish selected, the housing finish and end cap finish will match <input type="checkbox"/> SAMF SA Housing/Machine Finish End Caps <input type="checkbox"/> WPMF WP Housing/Machine Finish End Caps <input type="checkbox"/> BPMF BP Housing/Machine Finish End Caps <input type="checkbox"/> CCMF CC Housing/Machine Finish End Caps | <input type="checkbox"/> EMB_* Emergency Battery Pack(s) <input type="checkbox"/> EMC_* Emergency Circuit(s) <input type="checkbox"/> SOC* Occupancy Sensor <input type="checkbox"/> SDL* Daylight Sensor <input type="checkbox"/> 2C 2 Circuit (Direct Light and Indirect Light (Controlled Independently)) <input type="checkbox"/> BCS* Brilliant Communications Solutions (wired/wireless) BCS: includes wired and wireless integration from our partners at nLight™, Enlighted, Legrand, Crestron, Osram, Lutron and many more. Contact Extant for details. EMB: Specify quantity of battery packs. Minimum 4' unit. EMC: Specify quantity of emergency circuits. SOC & SDL: Specify spacing/location of sensors(s). | <input type="checkbox"/> SW Surface Wall <input type="checkbox"/> WR* Wall Mounted Rotational Arm (1" Rotational Hub) Note: Mounting hardware and arm match fixture finish. | *Only select when WR option selected above <input type="checkbox"/> L3 3" <input type="checkbox"/> L6 6" <input type="checkbox"/> L9 9" <input type="checkbox"/> L12 12" <input type="checkbox"/> L18 18" <input type="checkbox"/> L24 24" <input type="checkbox"/> L_ *Custom Length | *Only select when WR option selected above <input type="checkbox"/> NC No Coverplate <input type="checkbox"/> 4R 4" Round Coverplate <input type="checkbox"/> 4S 4" Square Coverplate <input type="checkbox"/> 2R 2-1/2" Round Coverplate <input type="checkbox"/> 2S 2" Square Coverplate |



Dimensions

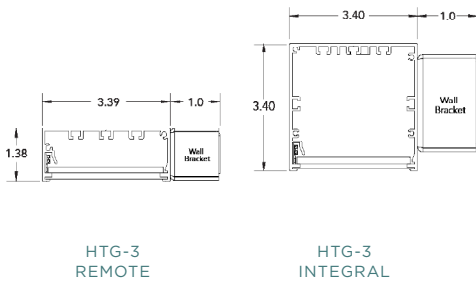

HTG-3
REMOTE

HTG-3
INTEGRAL

Note: Wall bracket not included when "WR" Rotational Arm mounting is selected.

Patterns

L__X__
L-Shape
Provide Ax B
Example: L6'x4'

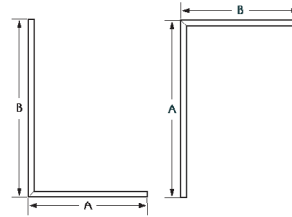

Note: ¹Patterns shown and ordered in Plan View.
²Patterns are not available on Arm Mount fixtures

Specifications

Construction One-piece heavy gauge 6063 extruded aluminum housing. Precision-machined aluminum end caps.

Optics Microstructure EdgeTech Optics (MEO)TM utilizes high efficiency Microstructure Lenses and Light Guide Plates for high optical extraction and precise light management. Specify Batwing, Glare Control, Diffused (Lambertian) or Wall Wash Optics.

Light Output (3) Standard lumen packages are available: Low (DLL), Medium (DML) and High (DHL). Specified Lumen Output (SLO) packages available. Please see the (SLO) configurator at ExtantLighting.com.

LEDs Latest generation of premium Nichia 3-step MacAdam Ellipse LED's available in (90+ CRI) 2700K, 3000K, 3500K, 4000K or (80+ CRI) 3000K, 3500K or 4000K. LED modules are easily accessible and replaceable.

Voltage Universal 120/277V (VU) and 347V (V3) available. Consult factory for driver options when 347V is specified.

Emergency Battery Factory provided low profile 10W emergency battery for UL924 required 90-minute run time (optional).

Finish Standard finishes include silver anodized, powder coated white or powder coated black. Custom anodized and powder coated finishes available (RAL number matched).

Continuous Rows Innovative Toolless Latch System ensures simple installation. Seamless continuous rows with no lens breaks, pixelation or hotspots up to 400 feet with MEO DF or 250 feet with MEO GC.

Patterns Standard L Pattern (L) available. Custom patterns available.

Mounting Wall Mount and Wall Mounted Rotational Arm with 1" rotational hub.

Approvals UL and cUL Listed. Approved for Dry/Damp locations. Made in the USA.

Lumen Maintenance (L70) 70% of initial light output = Reported > 60,000 hours | Calculated > 200,000 hours (L90) 90% of initial light output = Reported > 60,000 hours | Calculated > 200,000 hours.

Warranty HTG 3 offered with a 5-year limited warranty. 5-year limited warranty covers LED, Driver and fixture. For further details, refer to General Warranty and Obligations at ExtantLighting.com.

Patents Extant Lightings intellectual property is protected under Patent Pending Status by the U.S. Patent Office.

* Due to our culture of always striving for product enhancement, specifications and information within this document are subject to change without notice. 2020 Extant Lighting, Inc. All rights reserved.

Continuous Row Detail

NOTE: Detail below is specific to the Surface Wall only. For additional Continuous Row Detail, please visit ExtantLighting.com

| Nominal Row Length (ft) | Segment Lengths (ft) | Overall Row Length |
|-------------------------|-----------------------|--------------------|
| 9 | 5 + 4 | 9' 1/2" |
| 10 | 6 + 4 | 10' 1/2" |
| 11 | 7 + 4 | 11' 1/2" |
| 12 | 8 + 4 | 12' 1/2" |
| 13 | 8 + 5 | 13' 1/2" |
| 14 | 8 + 6 | 14' 1/2" |
| 15 | 8 + 7 | 15' 1/2" |
| 16 | 8 + 8 | 16' 1/2" |
| 17 | 8 + 5 + 4 | 17' 1/2" |
| 18 | 8 + 6 + 4 | 18' 1/2" |
| 19 | 8 + 7 + 4 | 19' 1/2" |
| 20 | 8 + 8 + 4 | 20' 1/2" |
| 21 | 8 + 8 + 5 | 21' 1/2" |
| 22 | 8 + 8 + 6 | 22' 1/2" |
| 23 | 8 + 8 + 7 | 23' 1/2" |
| 24 | 8 + 8 + 8 | 24' 1/2" |
| 25 | 8 + 8 + 5 + 4 | 25' 1/2" |
| 26 | 8 + 8 + 6 + 4 | 26' 1/2" |
| 27 | 8 + 8 + 7 + 4 | 27' 1/2" |
| 28 | 8 + 8 + 8 + 4 | 28' 1/2" |
| 29 | 8 + 8 + 8 + 5 | 29' 1/2" |
| 30 | 8 + 8 + 8 + 6 | 30' 1/2" |
| 31 | 8 + 8 + 8 + 7 | 31' 1/2" |
| 32 | 8 + 8 + 8 + 8 | 32' 1/2" |
| 33 | 8 + 8 + 8 + 5 + 4 | 33' 1/2" |
| 34 | 8 + 8 + 8 + 6 + 4 | 34' 1/2" |
| 35 | 8 + 8 + 8 + 7 + 4 | 35' 1/2" |
| 36 | 8 + 8 + 8 + 8 + 4 | 36' 1/2" |
| 37 | 8 + 8 + 8 + 8 + 5 | 37' 1/2" |
| 38 | 8 + 8 + 8 + 8 + 6 | 38' 1/2" |
| 39 | 8 + 8 + 8 + 8 + 7 | 39' 1/2" |
| 40 | 8 + 8 + 8 + 8 + 8 | 40' 1/2" |
| 41 | 8 + 8 + 8 + 8 + 5 + 4 | 41' 1/2" |
| 42 | 8 + 8 + 8 + 8 + 6 + 4 | 42' 1/2" |
| 43 | 8 + 8 + 8 + 8 + 7 + 4 | 43' 1/2" |
| 44 | 8 + 8 + 8 + 8 + 8 + 4 | 44' 1/2" |
| 45 | 8 + 8 + 8 + 8 + 8 + 5 | 45' 1/2" |
| 46 | 8 + 8 + 8 + 8 + 8 + 6 | 46' 1/2" |
| 47 | 8 + 8 + 8 + 8 + 8 + 7 | 47' 1/2" |
| 48 | 8 + 8 + 8 + 8 + 8 + 8 | 48' 1/2" |



Microstructure EdgeTech Optics (MEO)™

Our innovative MEO™ design utilizes high efficiency Microstructure Lenses and Light Guide Plates for high optical extraction and precise light management. MEO™ delivers exceptional light quality with seamless illumination and uniformity with no pixelation, hot spots or lens breaks up to 400' continuous rows.

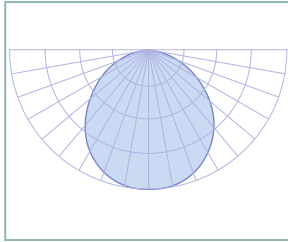

MEO DF
DIFFUSING

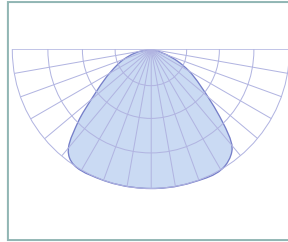

MEO GC
GLARE CONTROL

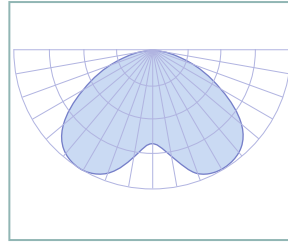

MEO BW
BATWING

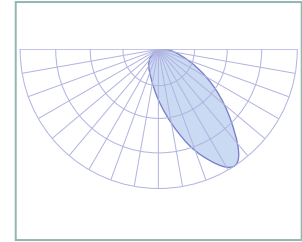

MEO WW
WALL-WASH -
33° OFF NADIR



Precision Refractive Optics (PRO)

Precision Refractive Optics (PRO) are designed to produce precise optic control for diverse design applications. PRO utilizes the latest in extruded lens technology that mounts directly to the LED board channel to give optimum control.

Please Note: The PRO optics are not a diffused light source. LED pixelation will be seen with this optic choice. If you want a completely diffused light source with no pixelation or hot spots, see our Microstructure EdgeTech Optics (MEO)™ options.

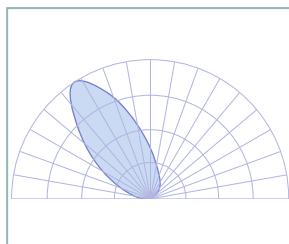

PRO AY
ASYMMETRIC

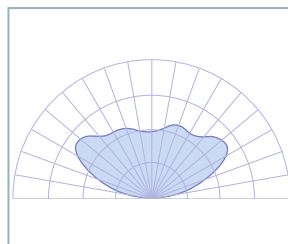

PRO WD
WIDE

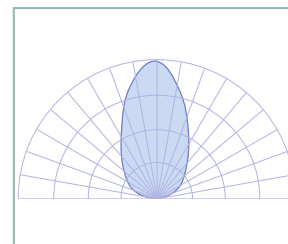

PRO NR
NARROW



Thoughtful Engineering...

Thoughtful engineering is at the core of all of our fixture designs. All of our products are thoughtfully engineered and include innovative features that create a sophisticated fixture that is also contractor friendly and easy to install and service.

PUSH AND EJECT SYSTEM

Innovative "Push and Eject" System allows for toolless removal and installation of the Light Guide Plate. This thoughtful engineering creates easy access into the housing for simple installation and serviceability.

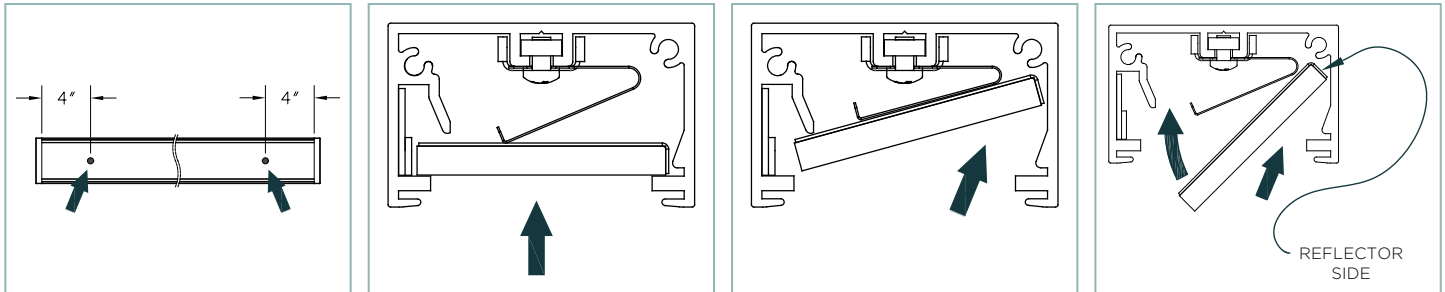

TOOLLESS LATCH SYSTEM

Our Toolless Latch System is designed to securely connect the extrusions of the continuous runs without the use of any tools, screws or external parts. Our innovative design allows the contractor to perfectly align the extrusion with the built-in alignment pins and cinch up the extrusion with the Toolless Latch System for a tight fit. The Toolless Latch System eliminates gaps and ensures perfect alignment.

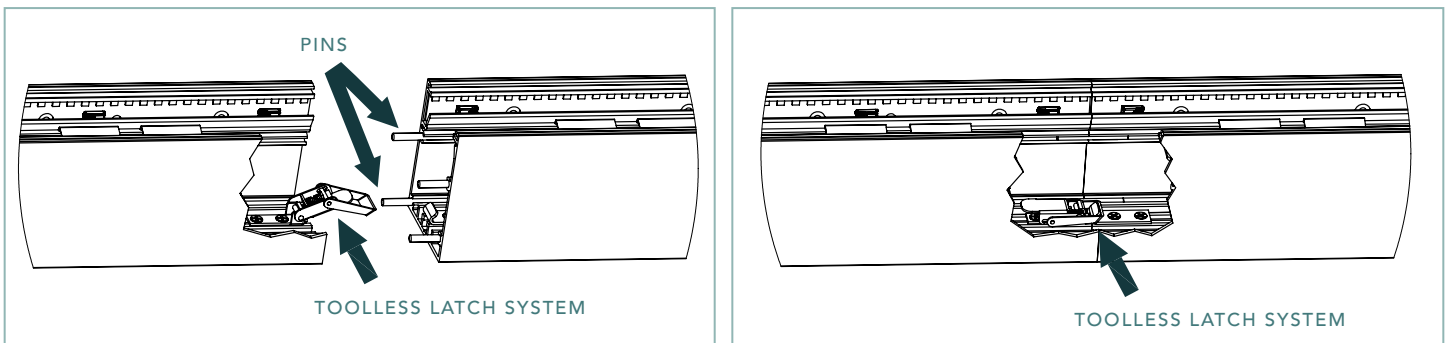

QUICK-CLICK 5-WIRE SYSTEM

Our Quick-Click 5-Wire System connects the continuous run through wiring with a simple push and click connection. The Quick-Click System is contractor friendly and decreases installation time and cost and ensures proper wiring.

