

DESCRIPTION

The Define series by Neo-Ray characterizes the ultimate in minimalist simplicity by providing clean, uniform lines of illumination in virtually any architectural environment. Powered by Eaton's most advanced linear LED technology, the Define series delivers outstanding efficacy in a variety of profile widths. 2", 3", 4" and 5" luminaire widths are all specifiable to the nearest foot as standard product and can be fitted with standard flush, asymmetric flush, regressed and drop lensing. Custom corners and transitions are also available. Robust construction and adaptable, modular components make installation simple and ensure laser straight runs.

Catalog #		Type
Project		
Comments		Date
Prepared by		

SPECIFICATION FEATURES

Construction

Housing extruded from 6063 aluminum. Nominal 2' -12' illuminated sections. Used in run configuration and/or individual fixtures. All components are RoHs compliant.

Lens

Snap in lens available in flush and drop lens profiles. Snap in end clips eliminate light leak and prevent moisture and insect ingress.

Finish

Fixture housings are high reflectance white using electrostatically applied polyester powder coat paint.

Electrical

Long-life LED system coupled with electrical driver to deliver optimal performance. LED's are available in 2700K, 3000K, 3500K or 4000K with a typical CRI ≤ 85. Projected life is 131,000 hours at L70.

Electronic drivers are available for 120-277V applications. Fixtures and electrical components certified to UL and CUL standards. Fixtures are damp location listed.

Controls

Equipped standard with a 0-10V continuous dimming driver compatible with most standard dimming devices (refer to website for specific compatibility reference).

Combine with FifthLight DALI and other energy saving products like sensors, daylighting controls and building management systems to maximize energy savings.

Mounting

Suspended.

Pendant with single aircraft cable and circular canopy. Standard length of canopy is 48".

Warranty

Five year warranty.

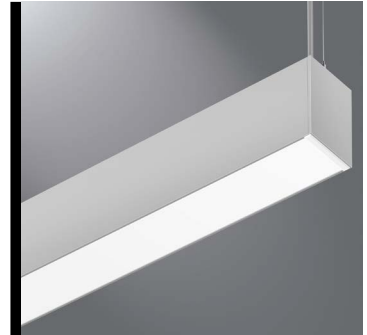

Define 4

Pendant

LED

Direct / Indirect

CERTIFICATION DATA
cULus - 1598
Damp Location Listed
LM79/LM80 Compliant
RoHS Compliant
Lumawatt Pro Wireless

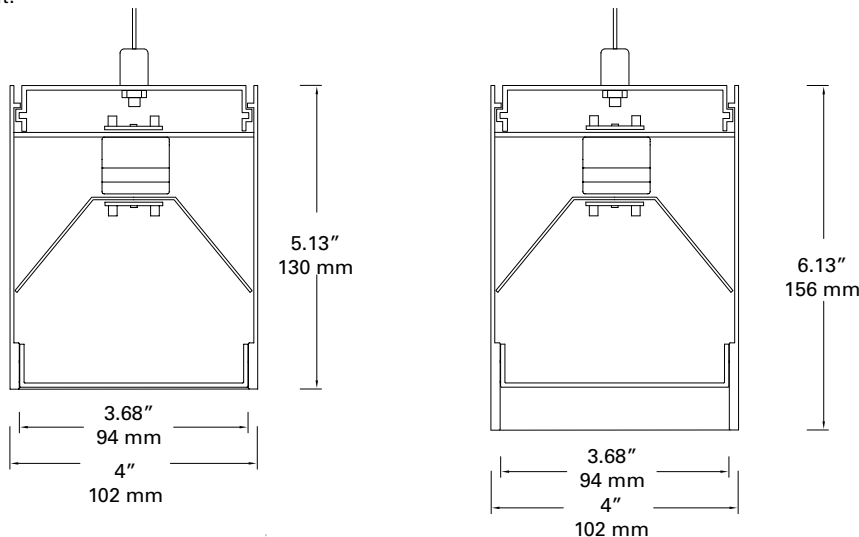

ORDERING INFORMATION

Sample Number: S124DIP-U1-235-SC48-ETG0048-1D-UDD-1-5-W

SERIES	LIGHT DISTRIBUTION	LIGHT LEVEL UP ¹	LIGHT LEVEL DOWN ¹	COLOR TEMP	MOUNTING CABLE LENGTH	CEILING TYPE ²	LENGTH ³ >>
S124 = Define 4	DIP = Direct / Indirect Pendant RDIP = Regressed Direct / Indirect Pendant	-ULO = Light Level ULO 488 Lm/Ft* -U1 = Light Level U1 949 Lm/Ft* -U2 = Light Level U2 1266 Lm/Ft* <small>See page 2 for lumen output *Tested with no lens up</small>	-LO = Light Level LO 331 Lm/Ft* -1 = Light Level 1 644 Lm/Ft* -2 = Light Level 2 1027 Lm/Ft* <small>See page 2 for lumen output *Tested with satin lens down</small>	27 = 2700K 30 = 3000K 35 = 3500K 40 = 4000K	-SC48 = 48" (std) Adjustable Cable -SC120 = 120" Adjustable Cable -SC240 = 240" Adjustable Cable	-ETG = 15/16" Flat T-Grid -FTG = 9/16" Flat T-Grid -ITG = 9/16" Interlude T-Grid -STG = 9/16" Slot T-Grid -JB = Gypsum board -ST = Structure	0024 = 2' Individual ⁴ 0048 = 4' Individual 0072 = 6' Individual 0096 = 8' Individual 0144 = 12' Individual XXXX = Configurable Run ⁵
CIRCUITING	CIRCUIT TYPE	VOLTAGE	LED DRIVER	SHIELDING DOWN	SHIELDING UP	COLOR	OPTIONS ⁹
-1 = Single Circuit -2 = Dual Circuit	D = Dimming (std) C = Non-Dimming B = Battery Pack ⁸ E = Emergency G = Bodine GTD	-1 = 120V -2 = 277V -U = Universal 120V-277V -3 = 347V ⁶	ED = Non-Dimming DD = 0-10V Dimming (std) HCD = 1% 0-10V Dimming 5L = DALI Dimming ⁷	-1 = Satin White Diffuser -3 = Asymmetric Flush -4 = Satin Drop Diffuser	-NA = No Lens (standard) -5 = Satin White Diffuser	-W = Matte White -S = Silver -B = Black -C = Custom Color	SVPD1 = Integrated Sensor ¹³ LWIPD1 = Lumawatt Pro Wireless Integral Sensor ¹³ -90 = 90-CRI (Lower Lumens) -R = GLR Fast Fusing -F = GMR Slow Fusing

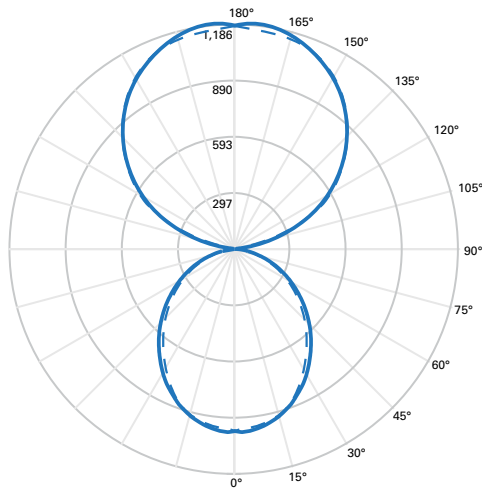

Filename: S124DIP-U1-135-SC48-SR0048-1D-UDD-1-NA-W
 Test Number: P190130
 Lumens: 6372 Lms
 Watts: 52 W
 LPW: 122.5 Lm/W
 CCT: 3500K

ZONAL LUMENS SUMMARY

Zone	Lumens	% Fixture
0°-30°	864	13.6
0°-40°	1378	21.6
0°-60°	2321	36.4
0°-90°	2856	44.8
90°-180°	3516	55.2

LUMINANCE DATA (cd/m²)

Vertical Angle	0°	45°	90°
45°	7550	6327	7442
55°	6914	5514	6799
65°	6199	4605	6031
75°	5304	3344	4883
85°	3530	1451	3149

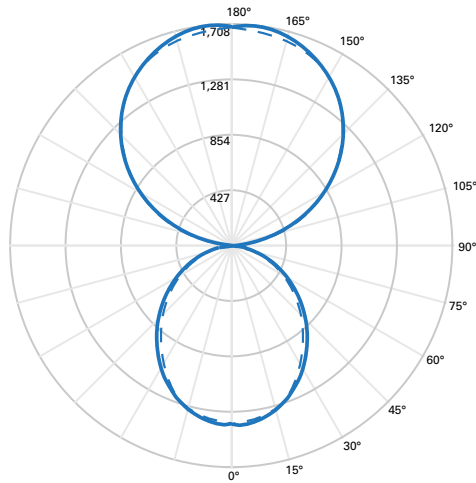

Filename: S124DIP-U2-235-SC48-SR0048-1D-UDD-1-NA-W
 Test Number: P28061
 Lumens: 9174 Lms
 Watts: 80.6 W
 LPW: 113.8 Lm/W
 CCT: 3500K

ZONAL LUMENS SUMMARY

Zone	Lumens	% Fixture
0°-30°	1244	13.6
0°-40°	1985	21.6
0°-60°	3342	36.4
0°-90°	4111	44.8
90°-180°	5063	55.2

LUMINANCE DATA (cd/m²)

Vertical Angle	0°	45°	90°
45°	10871	9110	10714
55°	9955	7938	9789
65°	8926	6631	8683
75°	7639	4815	7028
85°	5081	2091	4537

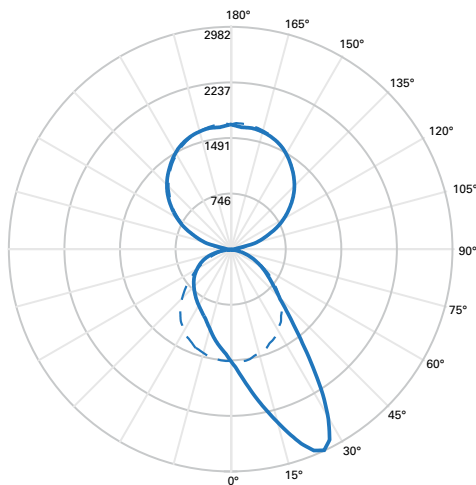

Filename: S124DIP-U2-235-SC48-SR0048-1D-UDD-1-NA-W
 Test Number: P28061
 Lumens: 9174 Lms
 Watts: 80.6 W
 LPW: 113.8 Lm/W
 CCT: 3500K

ZONAL LUMENS SUMMARY

Zone	Lumens	% Fixture
0°-30°	1356	14.3
0°-40°	2237	23.6
0°-60°	3661	38.7
0°-90°	4409	46.6
90°-180°	5062	53.4

CANDELA DISTRIBUTION (cd)

Vertical Angle	0°	90°	180°	270°
0°	1497	1497	1497	1497
10°	1497	2041	1490	1225
20°	1411	2780	1401	990
25°	1344	2982	1328	921
30°	1259	2635	1254	862
40°	1074	1318	1055	753
50°	803	752	787	648
60°	534	498	521	523
70°	303	285	293	379
80°	113	107	103	180
90°	0	0	0	0

LUMEN MAINTENANCE

Ambient Temperature	TM-21 Lumen Maintenance (60,000 hours)	Theoretical L70 (Hours)
25°C	84.29%	131,000

LIGHT OUTPUT, 3500K, ≤85CRI Typical

Light Level Up: ULO							Light Level Up: U1							Light Level Up: U2						
	Lm Total	% Dn	% Up	Lm/ft Down	Lm/ft Up	Total Watts		Lm Total	% Dn	% Up	Lm/ft Down	Lm/ft Up	Total Watts		Lm Total	% Dn	% Up	Lm/ft Down	Lm/ft Up	Total Watts
Light Level 0	3274	40.4%	59.6%	331	488	26.9	Light Level 0	5210	25.8%	74.2%	331	949	38.8	Light Level 0	6387	20.7%	80.3%	331	1266	52.2
Light Level 1	4526	56.9%	43.1%	644	488	40.1	Light Level 1	6372	40.4%	59.6%	644	949	52.0	Light Level 1	7638	33.7%	66.3%	644	1266	65.5
Light Level 2	6061	67.8%	32.2%	1027	488	55.2	Light Level 2	7908	52.0%	48.0%	1027	949	67.0	Light Level 2	9174	44.8%	55.2%	1027	1266	80.5

Correlation based on 4' luminaire S124DIP-U2-235-SC48-ST0048-1D-UDD-1-NA-W, Report: P28061

Mounting Information - Refer to installation instructions for detailed mounting information

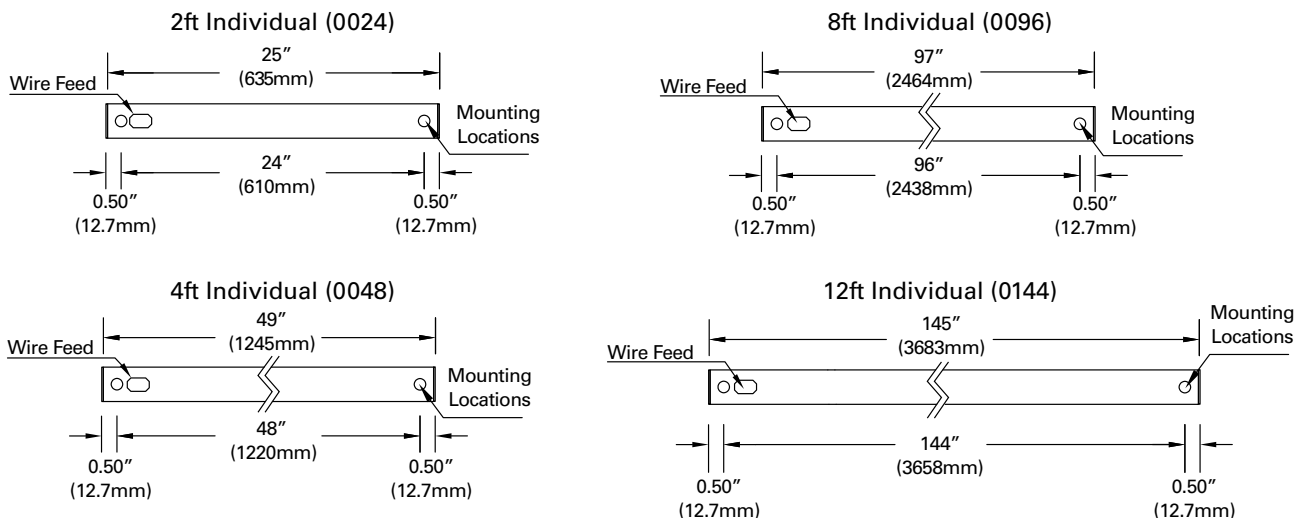

Lens Information - Direct (Downward) Lens Details

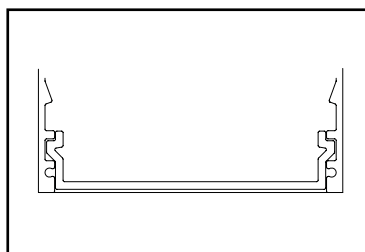

1 - Flush Satin Diffuser
Asymmetric Flush Diffuser

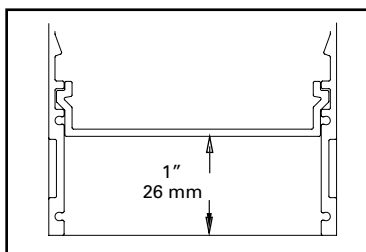

2 - Regressed Satin Diffuser

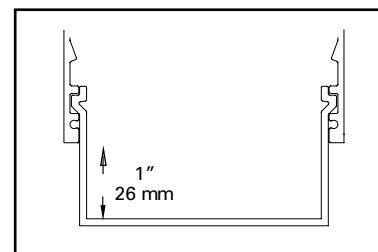

3 - Satin Drop Down Diffuser

Lens Information - Indirect (Upward) Lens Details

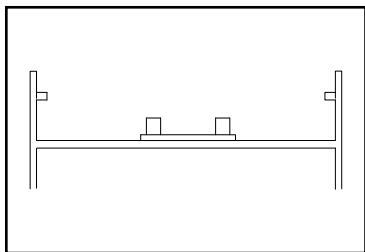

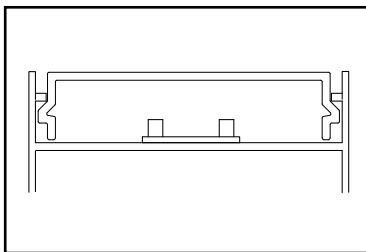

4 - NA - No Diffuser (standard)



5 - Flush Satin Diffuser

INTEGRATED SENSOR DETAILS AND PLACEMENT¹³

		Sensor Series		Occupancy Technology		Sensing Technology		Coverage Pattern	
		SV	Integrated Sensor for Local Control	P	Passive Infrared	D	Dimming Daylight Harvesting (Closed Loop)	1	~144 ft ²
4ft Individual		LWI	Lumawatt Pro Wireless Integral						
8ft Individual									
12ft Individual									

NOTES

- Additional lower light levels available. Please consult factory for specific details.
- Not all ceiling types are shown; consult factory for specific ceiling types not listed.
- All lengths are nominal. Refer to submittal drawings for actual sizes.
- Not all dimming options available for every length; please consult factory for specific details.
- For configurable runs specify length to nearest foot. Standard runs ship in 12ft increments. Ensure to specify 8ft increments if 12ft are too large to receive. Additional charges may apply; please consult factory for details.
- 347V is achieved using remote transformer.
- FifthLight DALI is achieved using digital analog converter.
- Battery pack options are not available in every length; please consult factory for specific details. Battery pack is remote installation only.
- For all options; consult factory for specific requirements.
- Not available with 347V circuit.
- Asymmetric lens is not available as standard product on regressed housing RDR.
- Standard product is configured with snap-in lens end caps at the beginning and end of a run or individual fixture. End caps are provided for ease of installation and removal of the lens and eliminate light leak from the end of the fixture when flush satin lens is selected. Please contact factory if lens end-caps are not desired as alternate configurations are available.
- Integrated LumaWatt Pro Sensor available as a PDR in 4ft, 8ft, and 12ft configurations. Continuous runs and alternate lengths are also available. Please consult factory for details. One sensor for every 8ft of fixture length. Standard configurations include Universal voltage, single circuit and 'DD' driver selection. Not available with regressed housing or emergency options.