



RING | KURL



RING

RING

INTRO

RING creates a design statement for contemporary and traditional architectural interiors. The ring of light is both decorative and highly functional. Luminaires are perfectly suited for a multitude of applications like office areas, retail spaces, places of worship, museums and galleries as well as high ceiling applications such as lobbies and atriums.

HIGHLIGHTS

- Custom diameters available to special order
- Ten standard diameters available
- High power LEDs provide functional levels of illumination
- 0-10V dimming for mood and ambiance
- Efficacy over 67lm/W
- Direct illumination or a combination of direct and indirect illumination

SUSPENSION STYLES

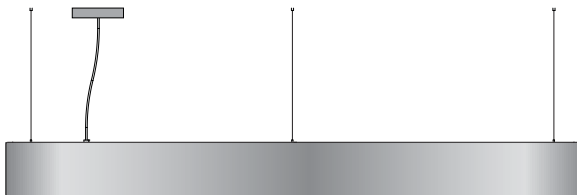

Type A

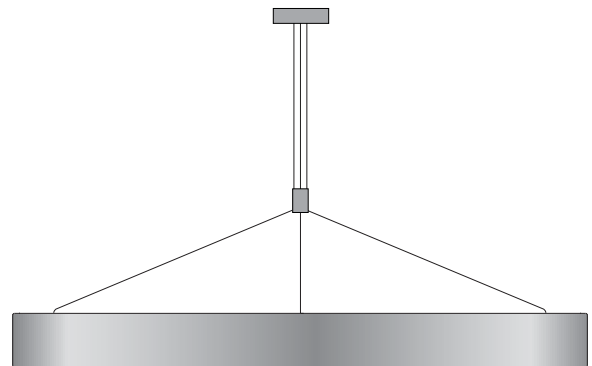

Type B



RING

RING

DIAMETERS

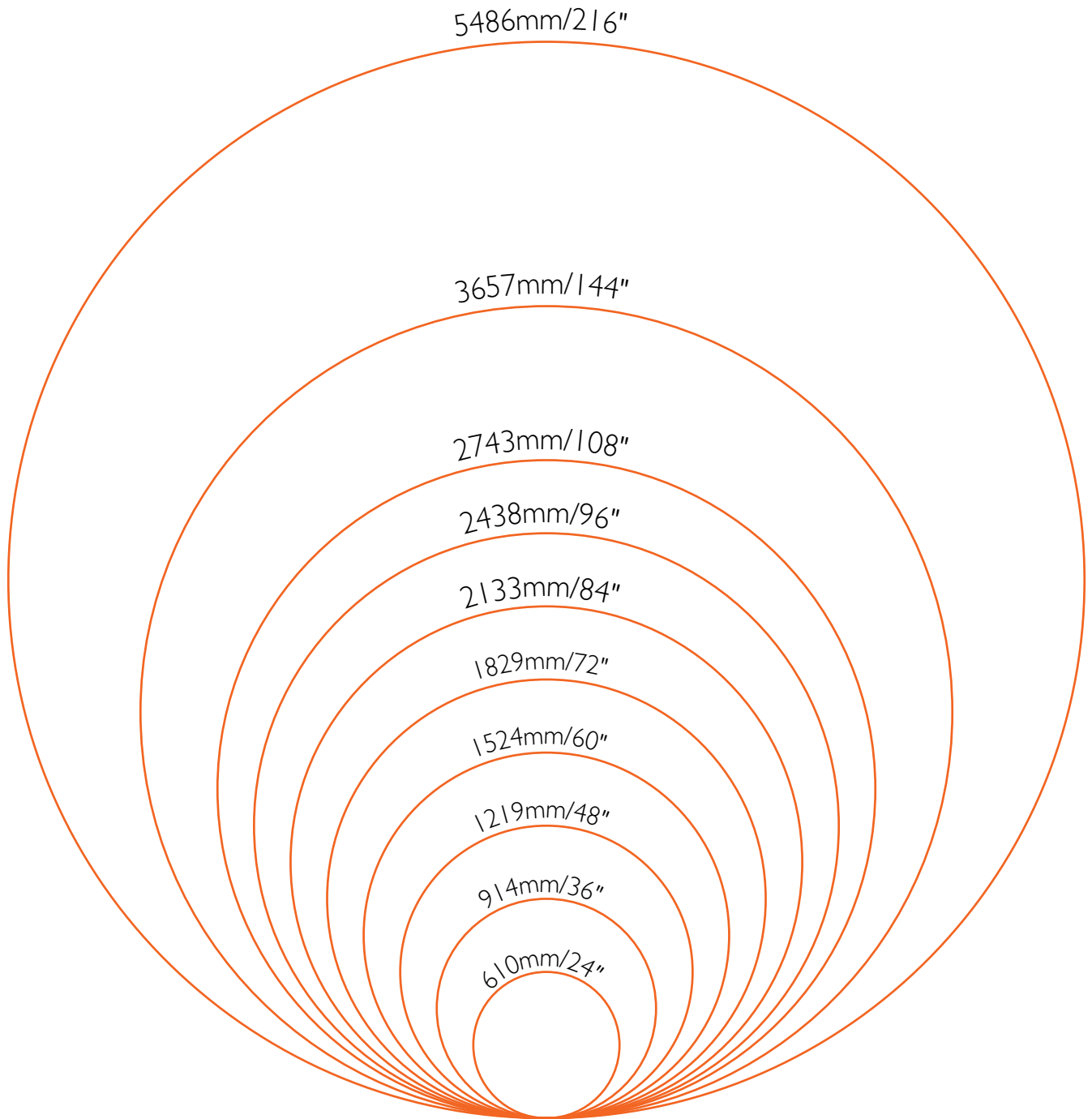

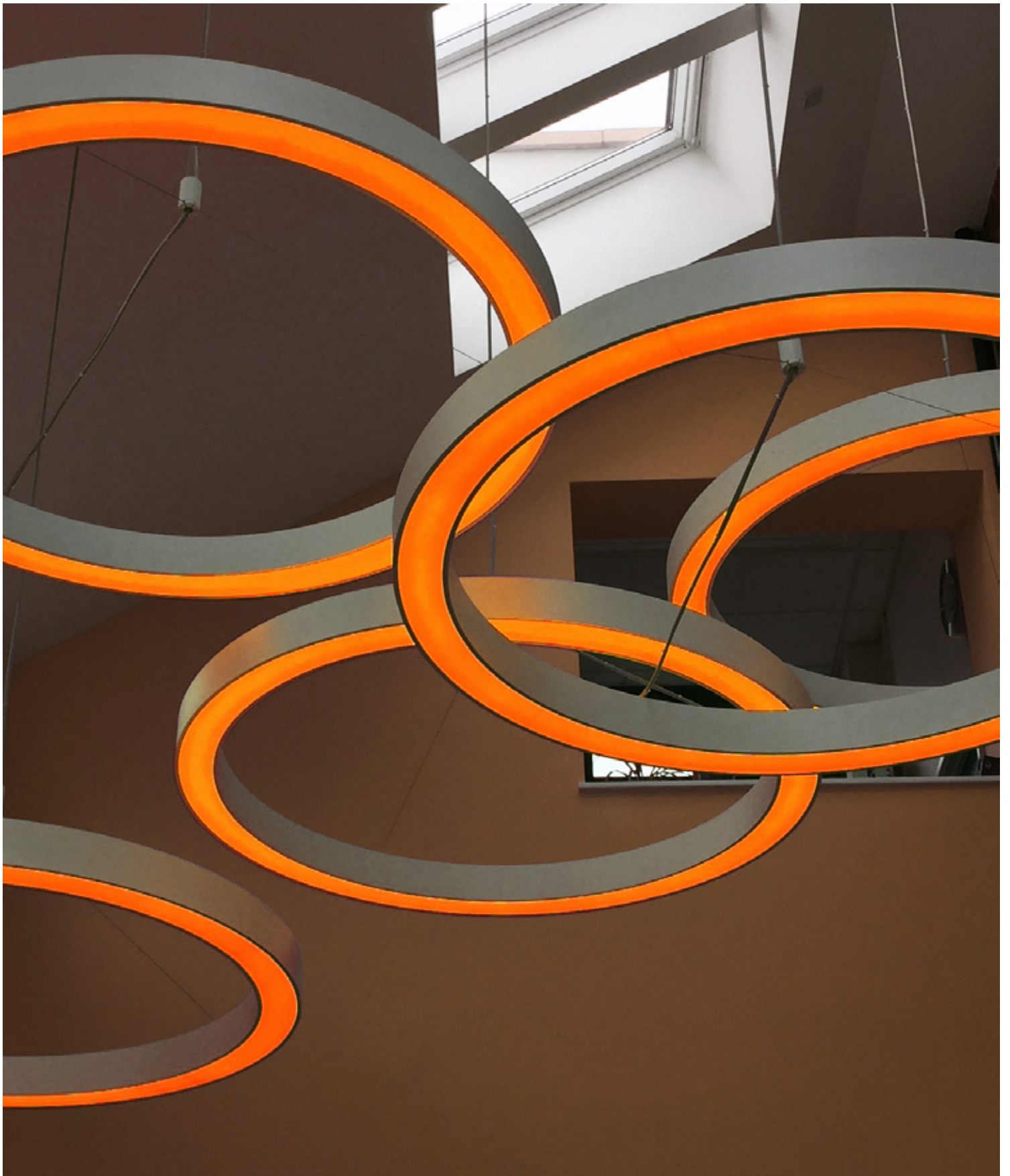

RING

RING

OPTIONS



STATIC COLOR DIRECT & WHITE LED INDIRECT
⌘ WEB PIN™ 207



STATIC COLOR LED DIRECT
⌘ WEB PIN™ 296

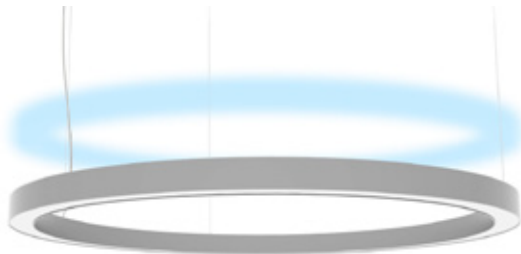

WHITE LED DIRECT & STATIC COLOR INDIRECT
⌘ WEB PIN™ 268



WHITE LED DIRECT
⌘ WEB PIN™ 100



WHITE LED DIRECT & INDIRECT
⌘ WEB PIN™ 238



RING



KURL

KURI

OPTIONS

WEB PIN™ 116

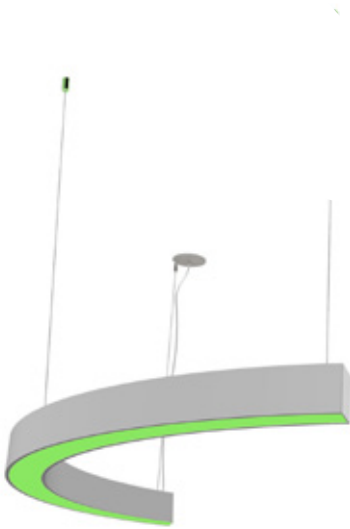

STATIC COLOR LED
DIRECT ILLUMINATION

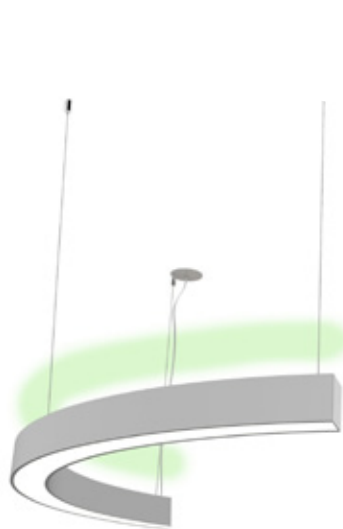

WHITE LED DIRECT &
INDIRECT ILLUMINATION

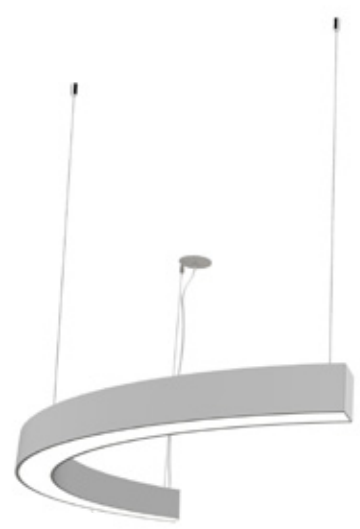

WHITE LED DIRECT
ILLUMINATION

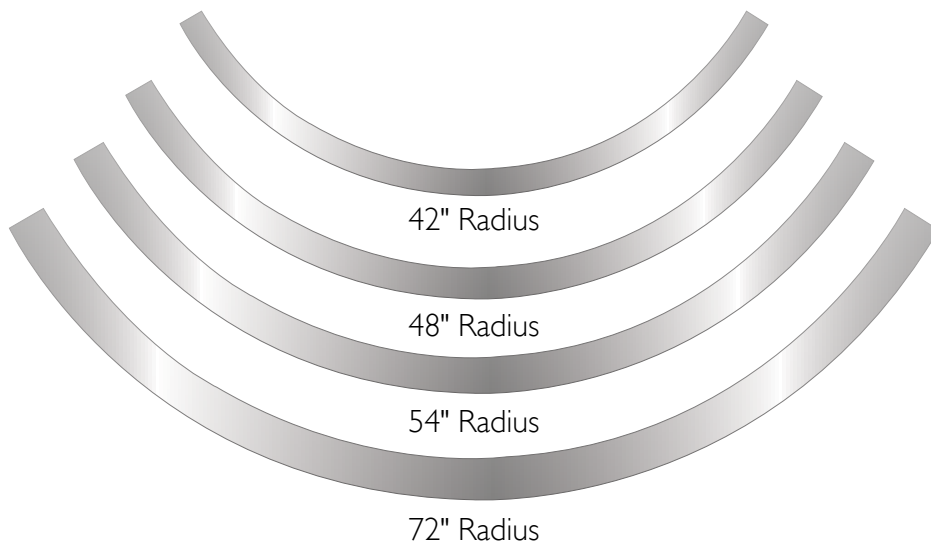



KURL

RING | KURL

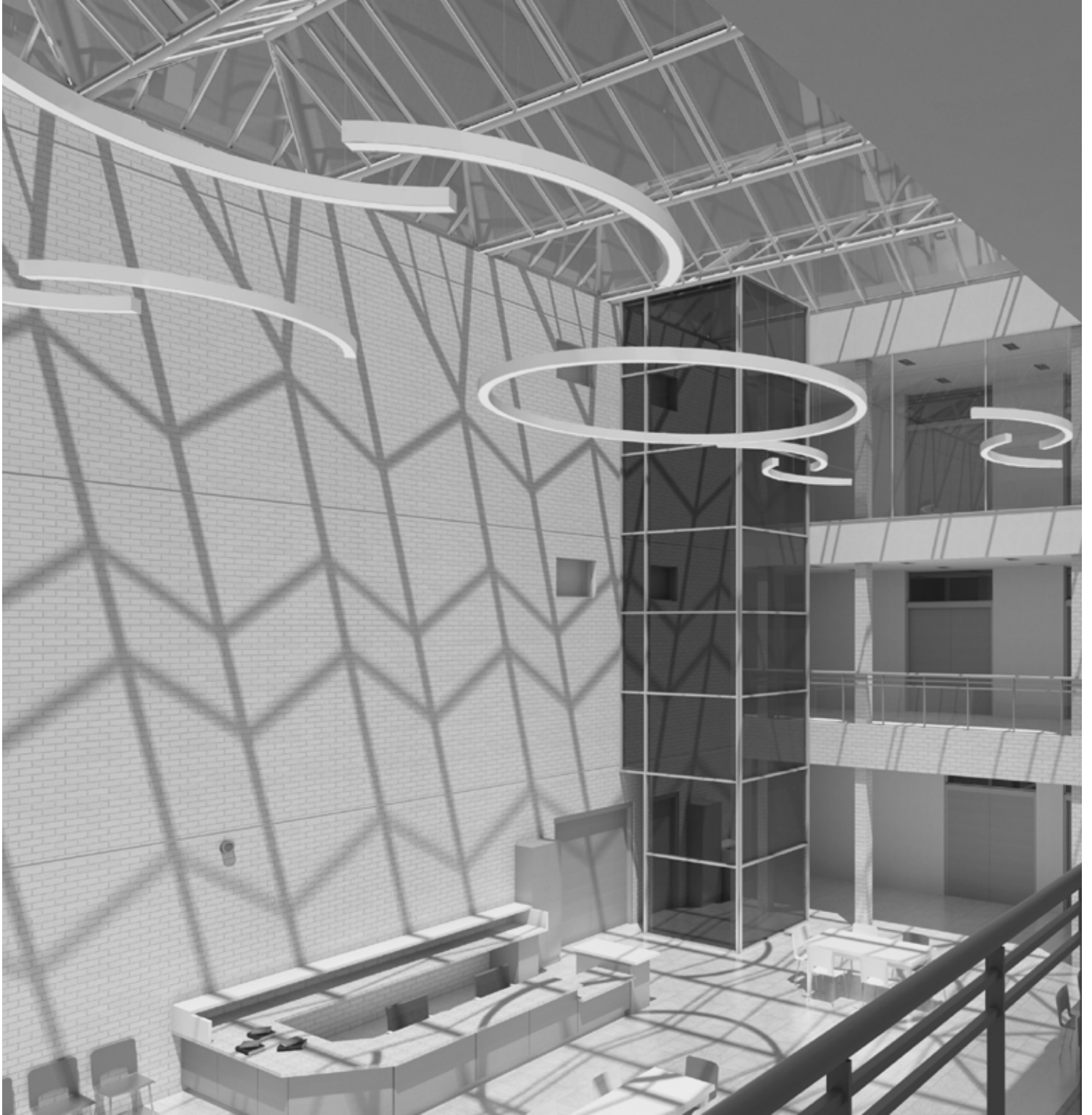

 **betacalco**[™]

sales@betacalco.com | www.betacalco.com