

HCB15 | Swell™ GENERAL INFORMATION

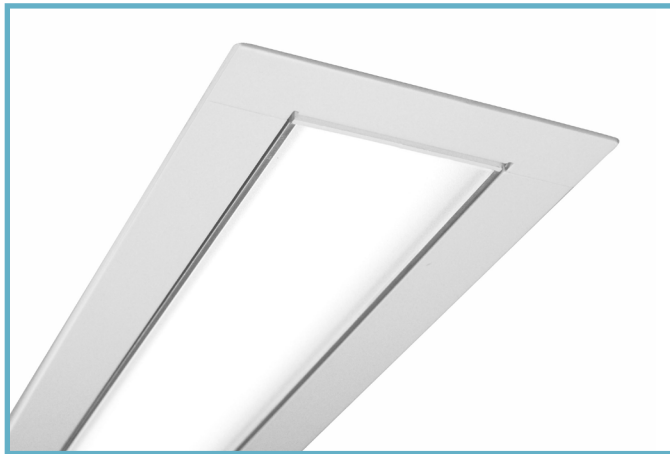

2" wide aperture linear recessed LED luminaire, Illuminated by BIOS®

Project: _____ Type: _____



FEATURES

The HCB15 is a linear recessed LED luminaire tailored for health-centric lighting installations. The 2" wide aperture is available with multiple lens options and constructed for installation in common grid ceilings or in hard walls and ceilings with flange and trimless variants.

The HCB15 fixture is embedded with BIOS SkyBlue® circadian solutions to produce the healthy "blue sky" light signal needed to stimulate human circadian biology. This specific light wavelength communicates directly with human biology through a non-visual photoreceptor to regulate circadian rhythms, providing healthier sleep patterns and ultimately, better health.

SPECIFICATIONS

Fixture housing and trim elements made of extruded aluminum and 16 ga. sheet aluminum and steel parts

Model options available for typical 9/16" and 15/16" grid ceilings or hard walls/ceilings with flange and trimless mounting (wall installation requires accessory mounting brackets)

Basic continuous run fixtures provided with 18 ga. wiring harness for 6 Amp maximum load (consult factory for runs requiring multiple circuits, sensor integration, etc.)

Lens options include frosted acrylic flush fit, 1" drop style with lensed ends or a parabolic louver

Standard integral 120-277V driver offered with 0-10V dimming or non-dim

Integral 120-277V emergency battery backup available for 44" or 88" fixtures (consult factory for all other lengths/drivers, supplied with remote test switch/indicator plate assembly)

Standard light outputs are 575 and 760 lumens per foot

BIOS Static Spectrum or Dynamic LEDs available in 3000K, 3500K and 4000K, with a CRI of 80+ to 90 depending on color

Life: 50,000 hours L₇₀

Chicago plenum rated option available

Nominal weight is 2.8 lbs. per foot

Limited five year warranty

UL and C-UL listed for dry and damp locations

SECTIONS

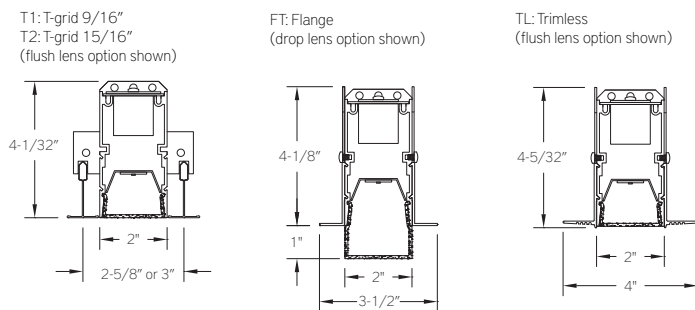

PERFORMANCE

NOMINAL LENGTH	LENS	OUTPUT	LUMENS/ft.	WATTS/ft.	LUMINAIRE LUMENS	EFFICACY (LPW)
44"	FLUSH	R: regular	575	9.8	2106	59
		H: high	760	13.8	2782	55

Note: All data reflects fixture with BIOS Static Spectrum 3500K LEDs

GET A QUOTE >

HCB15 -





MOUNTING	NOMINAL FIXTURE LENGTH**	CORRELATED COLOR TEMPERATURE	DRIVER	LIGHT OUTPUT (lumens per foot w/flush lens)	RUN CONFIGURATION	OPTIONS
T1: T-grid 9/16" T2: T-grid 15/16" FT: Flange trim TL: Trimless CF: consult factory for custom mounting	22: 22" 24: 24" (T1 or T2 w/SN ONLY) 44: 44" 48: 48" (T1 or T2 w/SN ONLY) 66: 66" 88: 88"	[BIOS static] BS30: 3000K-85 CRI BS35: 3500K-85 CRI BS40: 4000K-90 CRI [BIOS dynamic] BD30: 3000K-83 CRI BD35: 3500K-83 CRI BD40: 4000K-83 CRI	ND: non-dimming [Dimming] D: 0-10V, 1%	R: regular - 575 H: high - 760 CF: consult factory for custom output	SN: single ST: starter AD: adder TR: terminator	CP: Chicago plenum ED: emergency driver (44" or 88" fixtures) WS1: Wattstopper FS-205 ‡ ES1: EasySense SN102 ‡ ES2: EasySense SN200 ‡ ES3: EasySense SN300 ‡ EN1: Enlighted FS-D22 ‡ CF: consult factory for custom finish
					LENS F1: frosted flush F2: frosted drop L: louver	

** Actual dimension dependent on mounting option and run configuration
‡ See sensor section for driver compatibility information

MOUNTING

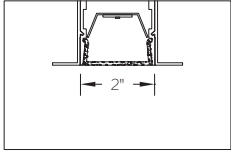
ORDERING CODE	DESCRIPTION	SPECIFICATIONS
T1 T2	T-grid ceiling 9/16" T-grid ceiling 15/16"	<ul style="list-style-type: none"> • 16 ga. brackets locate housing onto T-bar and allow 5/8" of vertical adjustment to accommodate various height T-bar • Housing secured with support wires (by others) • Exposed flange trim in matte white finish
FT	Flange - drywall ceiling or wall	<ul style="list-style-type: none"> • For wall installations or special ceiling conditions, order accessory mounting brackets 420-WB • 3/4" wide extruded aluminum trim flange in matte white finish • Housing secured with support wires or 1/4-20 threaded rod (by others)
TL	Trimless - drywall ceiling or wall	<ul style="list-style-type: none"> • Installs after 1/2" or 5/8" drywall • Housing secured with self-tapping drywall screws (by others) into blocking as required

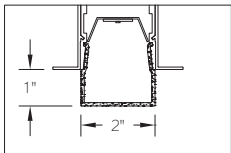
LENS OPTIONS



	ORDERING CODE	DESCRIPTION	SPECIFICATIONS	
 shown with flange trim option	F1	FROSTED FLUSH LENS	2" W frosted acrylic extrusion	
 shown with flange trim option	F2	FROSTED DROP LENS	2" W x 1" H frosted acrylic extrusion with matching acrylic end caps	
	L	LOUVER	Parabolic louver with 5/8" blades at 1" spacing, formed from diffuse, high reflectance aluminum and supplied with light diffusion film	

OPTIONS

	ORDERING CODE	DESCRIPTION	SPECIFICATIONS
	ED	EMERGENCY LED DRIVER	<ul style="list-style-type: none"> • Universal 120-277V input voltage emergency driver of 10W for 90 minutes • Available for 44" or 88" nominal length non-dim or 0-10V fixture only (consult factory for all other lengths) • Provided with combination test switch/indicator light mounted to wall plate for remote installation

INTEGRATED SENSORS

Note: Overall fixture length remains the same as models without a sensor. Total illuminated length is reduced by 5" nominal. For F1 flush lens option, sensors are mounted to flush filler piece. For F2 drop lens option, sensors are mounted to 1" H sheet formed cover.

	ORDERING CODE	BRAND AND MODEL	FUNCTIONS	
	WS1	Wattstopper FS-205	Occupancy and light level sensor	For use with on/off or 0-10V dimming drivers only
	EN1	Enlighted FS-D22	Occupancy, ambient light sensing, daylight harvesting, and environment monitoring for Enlighted control network	Provided with Advance sensor ready series 0-10V dimming drivers
	ES1	Philips EasySense SN102	Occupancy, daylight harvesting and task tuning sensor with simple grouping	Provided with Advance sensor ready series 0-10V dimming drivers
	ES2	Philips EasySense SN200	Occupancy, daylight harvesting and task tuning sensor with advance grouping	Provided with Advance sensor ready series 0-10V dimming drivers
	ES3	Philips EasySense SN300	Occupancy, daylight harvesting sensor for integration with Zigbee control networks	Provided with Advance sensor ready series 0-10V dimming drivers

ACCESSORIES

Note: Accessories sold separately

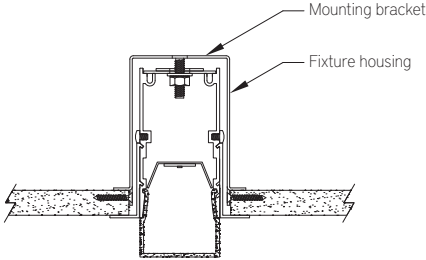
	ORDERING CODE	DESCRIPTION	SPECIFICATIONS
	420-WB	WALL MOUNT BRACKET	<ul style="list-style-type: none"> • For use when mounting fixtures with flange or trimless options in walls or restricted ceiling conditions • 16 ga. bracket clamps fixture to the backside of the mounting surface with provided hardware • Sold individually; two required for 22" - 48" nom. fixtures, three required for 66" - 88" nom. fixtures