

BSS210 | **bodhi**

2-1/8" wide LED luminaire with drop lens

Project: _____ Type: _____

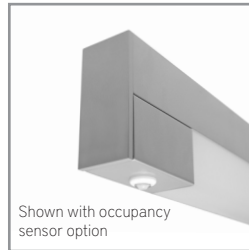
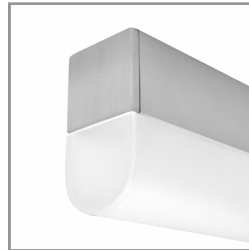

FEATURES

The BSS210 is a linear LED luminaire for general lighting applications. The 2-1/8" wide extruded aluminum housing is capped by a 2" tall, rectangular or rounded profile frosted acrylic lens that produces a wide distribution of diffuse illumination. 1/4" thick machined aluminum end caps finish off the fixture ends. Fixture with certain options available for 3-Day QuickShip.

SPECIFICATIONS

Fixture constructed of an extruded aluminum, extruded, frosted acrylic lens and machined aluminum end caps

Model variations offered in rectangular or rounded profiles for surface and wall mount or cable suspended applications with solid or luminous end options

Standard finishes as shown below

Available in nominal lengths of 2'-8' single fixtures and continuous runs

Basic continuous run fixtures provided with 18 ga. wiring harness for 6 Amp maximum load (consult factory for runs requiring multiple circuits, sensor integration, etc.)

Standard integral 120-277V driver offered with 0-10V dimming or non-dim (other dimming driver options available)

Integral 120-277V emergency battery backup available for 4' nominal non-dim or 0-10V (consult factory for all other lengths/drivers)

Standard light outputs are 600 or 1000 lumens per foot

LEDs available in 3000K, 3500K, 4000K and 5000K, within a 3 step MacAdam ellipse, all with 80+ CRI typical

Life: 50,000 hours L₇₀

Passive infrared occupancy sensor available (FOR RECTANGULAR PROFILE ONLY)

Limited five year warranty

UL and C-UL listed for dry and damp locations

SECTION

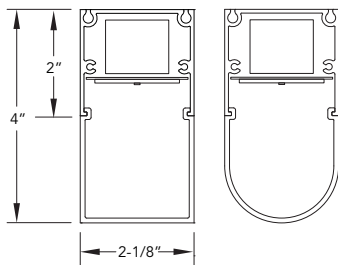

PERFORMANCE

NOMINAL LENGTH	OUTPUT	LUMENS/ft.	WATTS/ft.	LUMINAIRE LUMENS	EFFICACY (LPW)
4'	L: low	600	5.0	2244	120
	R: regular	1000	8.5	3736	118

Note: All data reflects fixtures with 3500K LEDs and rectangular profile and solid ends

GET A QUOTE >

BSS210 -



NOMINAL FIXTURE LENGTH* 2: 22-3/4" 3: 33-3/4" 4: 44-3/4" 5: 55-3/4" 6: 66-3/4" 7: 77-3/4" 8: 88-3/4"	CORRELATED COLOR TEMPERATURE 30: 3000K-80+ CRI 35: 3500K-80+ CRI 40: 4000K-80+ CRI 50: 5000K-80+ CRI	DRIVER ND: non-dimming [Dimming] D: 0-10V, 1% HES: Lutron EcoSystem, soft-on/fade-to-black, 1% H2: Lutron Hi-lume 2-wire forward phase, 1%, (120V ONLY) E5: Lutron EcoSystem 5-Series, 5% EL: eldoLED ECOdrive, 0-10V, 1%	LENS A: rectangular profile - solid end B: rectangular profile - luminous end C: rounded profile - solid end D: rounded profile - luminous end LIGHT OUTPUT (lumens per foot) L: low - 600 R: regular - 1000 CF: consult factory for custom output	MOUNT SM: surface mount WD: wall mount - direct C4: cable mount 4' cable length C8: cable mount 8' cable length CF: consult factory for custom mounting OPTIONS ED: emergency driver (4' non-dim or 0-10V only) S1: occ sensor pos.1 (see options section) S2: occ sensor pos.2 (see options section) S3: occ sensor pos.3 (see options section)	FINISH AW: architectural white (semi-matte) WH: white (semi-gloss) BL: black (semi-matte) MB: matte black ESS: environmental satin silver BZ: bronze PR: primer CF: consult factory for custom finish SA: satin anodize (requires additional lead time)	RUN CONFIGURATION SN: single ST: starter AD: adder TR: terminator
--	---	--	--	--	---	--



Highlighted fields denote QuickShip Options. See Complete 3-Day QuickShip Terms and Conditions available at www.bartcolighting.com/quickship. Purchase order must reference "QuickShip".

* Actual dimension dependent on run configuration

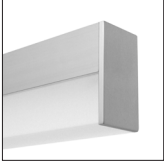
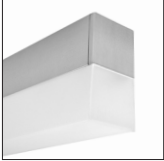
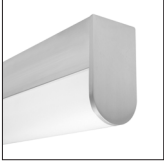
LENS

ORDERING CODE	DESCRIPTION	SPECIFICATIONS
	A RECTANGULAR SOLID END	Rectangular profile with full height aluminum end cap
	B RECTANGULAR LUMINOUS END	Rectangular profile with aluminum end cap and frosted acrylic lens end
	C ROUNDED SOLID END	Rounded profile with full height aluminum end cap
	D ROUNDED LUMINOUS END	Rounded profile with aluminum end cap and frosted acrylic lens end

OPTIONS

ORDERING CODE	DESCRIPTION	SPECIFICATIONS
ED	EMERGENCY LED DRIVER	<ul style="list-style-type: none"> • Universal 120-277V input voltage emergency driver delivers initial minimum power of 10W for 90 minutes • Available for 4' nominal length non-dim or 0-10V fixture only (consult factory for all other lengths/drivers)

OPTIONS

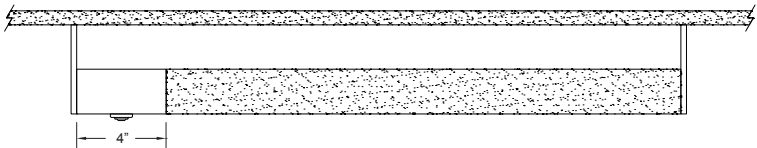
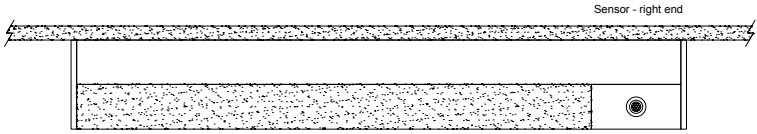
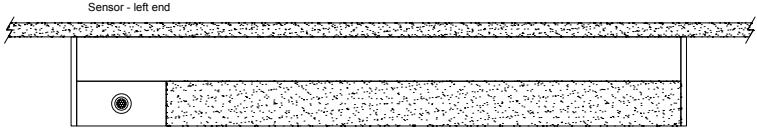
ORDERING CODE	DESCRIPTION	SPECIFICATIONS
	OCCUPANCY SENSOR	Passive infrared occupancy sensor with hold-off daylighting adjustment (10-120 foot candles) and time delay adjustment from 30 seconds to 30 minutes AVAILABLE FOR RECTANGULAR PROFILE ONLY
S1	Occupancy sensor – position 1	Sensor located on the top at an end 
S2	Occupancy sensor – position 2	Sensor located on the side at the right end 
S3	Occupancy sensor – position 3	Sensor located on the side at the left end 

MOUNTING

	ORDERING CODE	DESCRIPTION
	SM	SURFACE MOUNT Use appropriate fastener through Ø3/16" holes in housing
	WD	WALL MOUNT – DIRECT ORIENTATION Mounting option includes: • 1-7/8" H x 2-1/2" W aluminum bracket projects the fixture housing 3/4:" from the wall surface
	C4 and C8	CABLE MOUNT Mounting option includes: • Ø 1/16" x 48" (C4) or 96" (C8) aircraft cables • 60" (C4) or 108" (C8) power cable (in coordinating finish) • Bracket bars • Ø 5" white canopies • Ceiling couplers • Side exit cable grippers C8 mounting option available for QuickShip

LENGTH/MOUNTING DIMENSIONS

ORDERING CODE	LENGTH A*	LENGTH B*	LENGTH C*	LENGTH D*	LENGTH E*
2	22-3/4"	22-1/2"	22-1/4"	16-3/4"	19-1/2"
3	33-3/4"	33-1/2"	33-1/4"	27-3/4"	30-1/2"
4	44-3/4"	44-1/2"	44-1/4"	38-3/4"	41-1/2"
5	55-3/4"	55-1/2"	55-1/4"	49-3/4"	52-1/2"
6	66-3/4"	66-1/2"	66-1/4"	60-3/4"	63-1/2"
7	77-3/4"	77-1/2"	77-1/4"	71-3/4"	74-1/2"
8	88-3/4"	88-1/2"	88-1/4"	82-3/4"	85-1/2"

RUN CONFIGURATION INFORMATION

ORDERING CODE	DESCRIPTION
SN	Single
ST	Starter
AD	Adder
TR	Terminator

Note: Add 4" to dimension for any fixture using the S1, S2 or S3 occupancy sensor option

RUN INFORMATION

Back Plan - Surface Mount Single Fixture Option

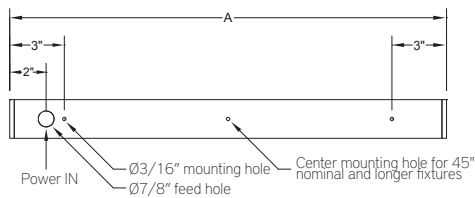

Side View - Surface Mount Single Fixture Option

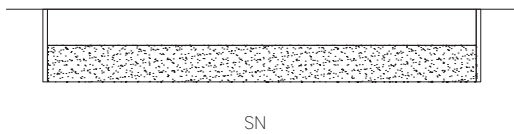

Back Plan - Surface Mount Continuous Run Option

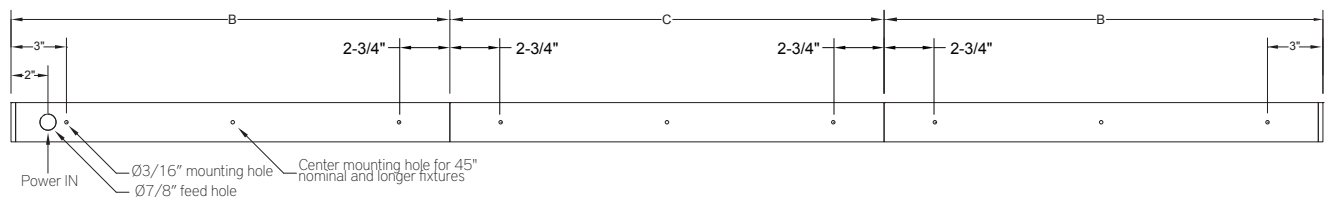

Side View - Surface Mount Continuous Run Option

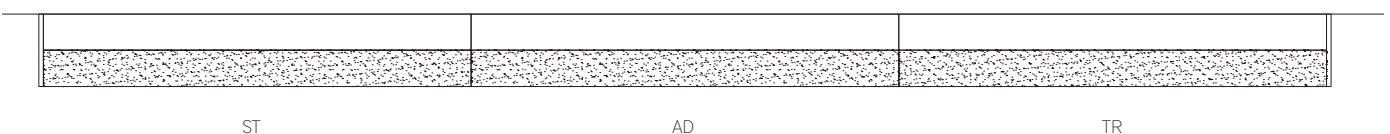

BSS210 | **bodhi**

2-1/8" wide LED luminaire with drop lens

RUN INFORMATION

Plan - Wall Mount Single Fixture Option

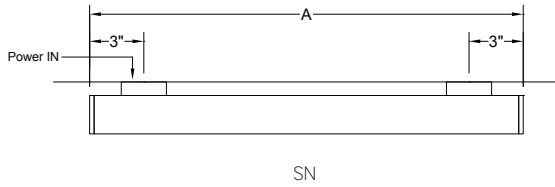

Plan - Wall Mount Continuous Run Option

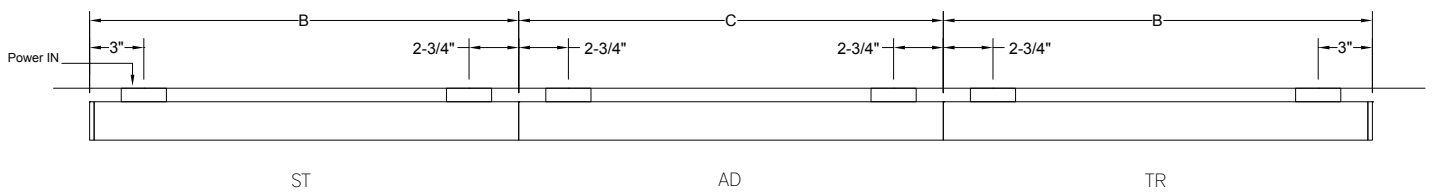

Side View - Cable Mount Single Fixture Option

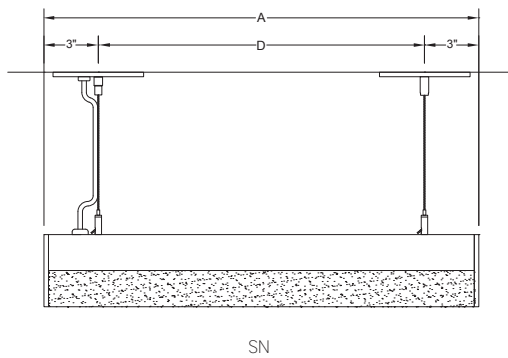

Side View - Cable Mount Continuous Run Option

