

BKSSL
SOLID STATE LIGHTING

the power of

CAMINO STAR™

PROJECT:	
TYPE:	
CATALOG NUMBER:	
SOURCE:	
NOTES:	

CATALOG NUMBER LOGIC

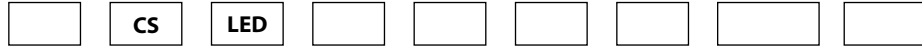

Example:

Material **Blank** - Aluminum
B - Brass (Style 'D' Only)

Series **CS** - Camino Star™ Pathlight

Source **LED** - 'e' Technology with Integral Driver
Designed for use with remote 12VAC BKSSL® transformers.

LED Type **e39** - 3WLED/2.7K **e41** - 3WLED/4K
e40 - 3WLED/3K **e45** - 3WLED/Amber

Finish

Aluminum & Brass Finishes			Brass Finishes		Premium Finish		
Powder Coat Color	Satin	Wrinkle	Machined	MAC	ABP	CMG	RMG
Bronze	BZP	BZW	Polished	POL	AMG Aleutian Mountain Granite	CRI Cracked Ice	SDS Sonoran Desert Sandstone
Black	BLP	BLW	Mitique™	MIT	AQW Antique White	CRM Cream	SMG Sierra Mountain Granite
White (Gloss)	WHP	WHW			BCM Black Chrome	HUG Hunter Green	TXF Textured Forest
Aluminum	SAP	—			BGE Beige	MDS Mojave Desert Sandstone	WCP Weathered Copper
Verde	—	VER			BPP Brown Patina Powder	NBP Natural Brass Powder	WIR Weathered Iron
					CAP Clear Anodized Powder	OCP Old Copper	<i>Also available in RAL Finishes See submittal SUB-1439-00</i>

Style C, D*, E, G, G1, G2, H, K
**Also available in Brass*

Base (Specify in inches) **6** - 6" with Anchor Base (Standard) **18** - 18" with Anchor Base
12 - 12" with Anchor Base **24** - 24" with Anchor Base

Mounting Options **PP12** - 12" Power Pipe™ Stake Mounting
PP18 - 18" Power Pipe™ Stake Mounting
SF - Stability Flange (for use with Power Pipe™)

Transformer Options **TRe20** - Integral TRe20 Electronic Transformer (for use with BKSSL® fixtures)
(105-300 VAC. 50/60 Hz. Non-Dimming. For use with 6-24" Base mounting only)

LM79 DATA

BK No.	CCT (Typ.)	Input Watts	CRI (Typ.)
e39	2700K White	2.8	90
e40	3000K White	2.8	90
e41	4000K White	2.8	75
e45	Amber (592nm)	2.8	~

L70 DATA

Minimum Rated Life (hrs.) 70% of initial lumens (L70)
50,000
50,000
50,000
50,000

***OPTICAL DATA**

Beam Type	Angle
Radial	360°h x 270°v
Radial	360°h x 270°v
Radial	360°h x 270°v
Radial	360°h x 270°v

B-K LIGHTING	40429 Brickyard Drive • Madera, CA 93636 • USA 559.438.5800 • FAX 559.438.5900 www.bklighting.com • info@bklighting.com	SUBMITTAL DATE 02-03-15	DRAWING NUMBER SUB001110
---------------------	---	-----------------------------------	------------------------------------

THIS DOCUMENT CONTAINS PROPRIETARY INFORMATION OF B-K LIGHTING, INC. AND ITS RECEIPT OR POSSESSION DOES NOT CONVEY ANY RIGHTS TO REPRODUCE, DISCLOSE ITS CONTENTS, OR TO MANUFACTURE, USE OR SELL ANYTHING IT MAY DESCRIBE. REPRODUCTION, DISCLOSURE OR USE WITHOUT SPECIFIC WRITTEN AUTHORIZATION OF B-K LIGHTING, INC. IS STRICTLY FORBIDDEN.

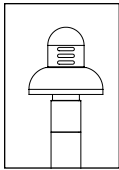

BKSSL
SOLID STATE LIGHTING

the power of 

CAMINO STAR™

PROJECT:

TYPE:

STYLE

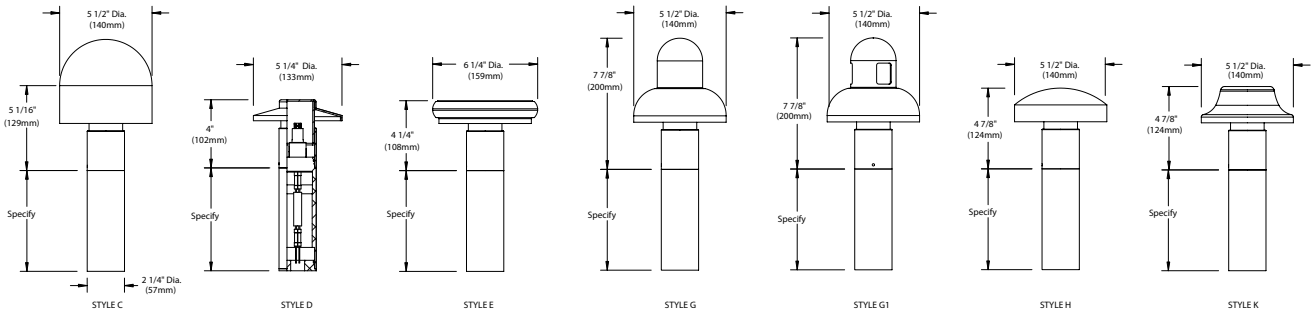

ANCHOR BASE

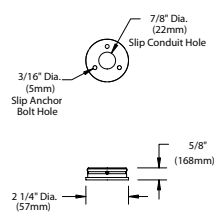

POWER PIPE™ MOUNTING OPTION

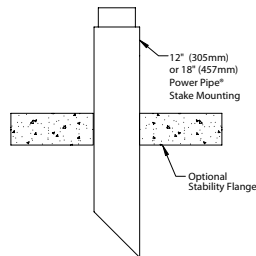

OPTIONAL STABILITY FLANGE

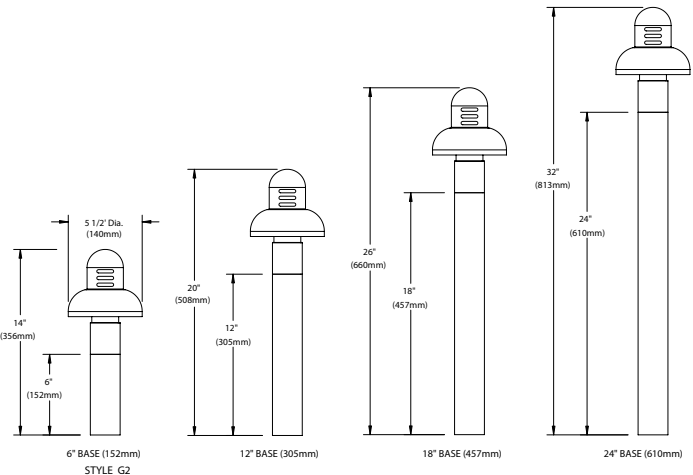
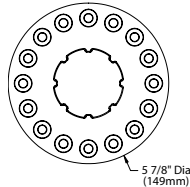

All dimensions indicated on this submittal are nominal.
Contact Technical Sales if you require more stringent specifications.

SPECIFICATIONS

GreenSource Initiative™

Metal and packaging components are made from recycled materials. Manufactured using renewable solar energy, produced on site. Returnable to manufacturer at end of life to ensure cradle-to-cradle handling. Packaging contains no chlorofluorocarbons (CFC's). Use of this product may qualify for GreenSource efficacy and recycling rebate(s). Consult www.bklighting.com/greensource for program requirements.

Materials

Furnished in Copper-Free Aluminum (Type 6061-T6). Style 'D' is additionally available in Brass (Type 360).

Style

Fully machined cap styles provide wide assortment of visual effects. Style 'C', 'D', 'E', 'G', 'H', and 'K' feature feature frosted Pyrex® lens. Fully adjustable, stainless steel cutoff shield minimizes aperture brightness. Style 'G1' and 'G2' additionally offer frosted acrylic upright opening for way-finding in addition to pathlight.

Body

Fully machined from solid billet. Design provides enclosed, water-proof wireway and integral heat sink for maximum component life. High temperature, silicone 'O' Ring provides water-tight seal.

BKSSL®

Integrated solid state system with 'e' technology is scalable for field upgrade. Modular design with electrical quick disconnects permit field maintenance. High power, forward throw source complies with ANSI C78.377 binning requirements. Exceeds ENERGY STAR® lumen maintenance requirements. LM-80 certified components. Side emitting optical grade lens delivers high efficiency, radial light distribution.

Integral non-dimming driver. Minimum 50,000 hour rated life at 70% of initial lumens (L70). BKSSL technology provides long life, significant energy reduction and exceptional thermal management.

Installation

Machined anchor base with 7/8\"/>

Transformer

For use with 12VAC  remote transformer or magnetic transformers only. B-K Lighting cannot guarantee performance with third party manufacturers' transformers. Also available with optional integral, TRe20 electronic transformer. 105-300VAC primary voltage. 50/60Hz. Non Dimming. 20VA maximum load.

Wiring

Teflon® coated, 18AWG, 600V, 250° C rated and certified to UL 1659 standard.

Hardware

Tamper-resistant, stainless steel hardware.

Finish

StarGuard®, our exclusive RoHS compliant, 15 stage chromate-free process cleans and conversion coats aluminum components prior to application of Class 'A' TGIC polyester powder coating. Brass components are available in powder coat or handcrafted metal finish.

Warranty

5 year limited warranty.

Certification and Listing

ITL tested to IESNA LM-79. Lighting Facts Registration per USDOE (www.lightingfacts.com). ETL Listed to ANSI/UL Standard 1598 and UL Subject 8750. Certified to CAN/CSA Standard C22.2 No. 250. RoHS compliant. Suitable for indoor or outdoor use. Suitable for use in wet locations. Suitable for installation within 4' of the ground. IP66 Rated. Made in USA.



*Teflon is a registered trademark of DuPont Corporation.

*Energy Star is a registered trademark of the United States Environmental Protection Agency.

*Pyrex is a registered trademark of Corning Incorporated.

B-K LIGHTING

40429 Brickyard Drive • Madera, CA 93638 • USA
559.438.5800 • FAX 559.438.5900
www.bklighting.com • info@bklighting.com

SUBMITTAL DATE
02-03-15

DRAWING NUMBER
SUB001110