

the power of 

MICRO NITE™ STAFF STAR™ STYLE L

PROJECT:	
TYPE:	
CATALOG NUMBER:	
SOURCE:	
NOTES:	

CATALOG NUMBER LOGIC

SF - **24** - **L** - **MN** - **LED** - **e37** - **NFL** - **BZP** - **13** - **11** - **A** - **SF**

Example:

Series **SF** - Staff Star™ Pathlight

Stem Length **24**
24", 30", 36", 42", 48", *54", *60", *66", or *72"
(Specify in inches) * For use with Standard Anchor Base Only

Style **L** - 90° Radius

Fixture **MN** - Micro Nite Star™

Source **LED** - 'e' Technology with Integral Driver
Designed for use with remote 12VAC BKSSL® transformers.

LED Type
e37 - 8WLED/2.7K **e17** - 8WLED/4K
e16 - 8WLED/3K **e21** - 8WLED/Amber

Optics*
SP - Spot (Green Indicator) **NFL** - Narrow Flood (Yellow Indicator) **FL** - Flood (Blue Indicator)

Finish
Aluminum Finish **Premium Finish**

Powder Coat Color	Satin	Wrinkle	ABP	CMG	RMG
Bronze	BZP	BZW	Antique Brass Powder	Cascade Mountain Granite	Rocky Mountain Granite
Black	BLP	BLW	AMG Aleutian Mountain Granite	CRI Cracked Ice	SDS Sonoran Desert Sandstone
White (Gloss)	WHP	WHW	AQW Antique White	CRM Cream	SMG Sierra Mountain Granite
Aluminum	SAP	—	BCM Black Chrome	HUG Hunter Green	TXF Textured Forest
Verde	—	VER	BGE Beige	MDS Mojave Desert Sandstone	WCP Weathered Copper
			BPP Brown Patina Powder	NBP Natural Brass Powder	WIR Weathered Iron
			CAP Clear Anodized Powder	OCP Old Copper	<i>Also available in RAL Finishes See submittal SUB-1439-00</i>

Lens Type **12** - Soft Focus Lens **13** - Rectilinear Lens

Shielding **11** - Honeycomb Baffle

Cap Style **A** - 45° **B** - 90° **C** - Flush **D** - 45° less Weep Hole (Interior Use Only) **E** - 90° less Weep Hole (Interior Use Only)

Options

- Blank** - Anchor Base (Standard, for use with remote transformer)
- PP18B** - 18" Power Pipe™ stake with 'B' Cap (for use with remote transformer)
- PP-TR20** - Power Pipe™ "T" option with 18" stake and TR20 Electronic Transformer** (105-300 VAC, 50/60 Hz, Non-Dimming)
**For use with up to 48" maximum stem length
- SF** - Stability Flange (for use with Power Pipe™)

DRIVER DATA

Input Volts 12VAC/DC 50/60Hz	InRush Current <250mA MAX (non-dimmed)	Dimmable Magnetic Low Voltage Dimmer	Operation Ambient Temperature -10°F-130°F
--	--	--	---

LM79 DATA

BK No.	CCT (Typ.)	Input Watts (Typ.)	CRI (Typ.)
e37	2700K	8.3	90
e16	3100K	8.3	90
e17	4100K	8.3	75
e21	Amber (590nm)	7.8	~

L70 DATA

Minimum Rated Life (hrs.) 70% of initial lumens (L70)
50,000
50,000
50,000
50,000

***OPTICAL DATA**

Beam Type	Angle	CBCP	Visual Indicator
Spot	20°	2934	Green Dot
Narrow Flood	25°	1252	Yellow Dot
Flood	30°	945	Blue Dot

B-K LIGHTING	40429 Brickyard Drive • Madera, CA 93636 • USA 559.438.5800 • FAX 559.438.5900 www.bklighting.com • info@bklighting.com	SUBMITTAL DATE 01-16-15	DRAWING NUMBER SUB-2348-00
---------------------	---	----------------------------	-------------------------------

THIS DOCUMENT CONTAINS PROPRIETARY INFORMATION OF B-K LIGHTING, INC. AND ITS RECEIPT OR POSSESSION DOES NOT CONVEY ANY RIGHTS TO REPRODUCE, DISCLOSE ITS CONTENTS, OR TO MANUFACTURE, USE OR SELL ANYTHING IT MAY DESCRIBE. REPRODUCTION, DISCLOSURE OR USE WITHOUT SPECIFIC WRITTEN AUTHORIZATION OF B-K LIGHTING, INC. IS STRICTLY FORBIDDEN.

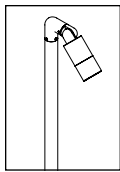

the power of 

MICRO NITE™ STAFF STAR™ STYLE L

PROJECT:	
TYPE:	

ANCHOR BASE

POWER PIPE 'T' (Mounting Option)

POWER PIPE™ (Mounting Option)

"A/D" CAP

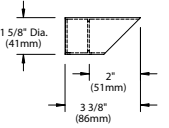

"B/E" CAP

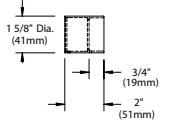

"C" CAP

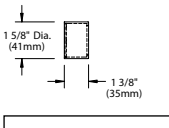

STABILITY FLANGE (optional)

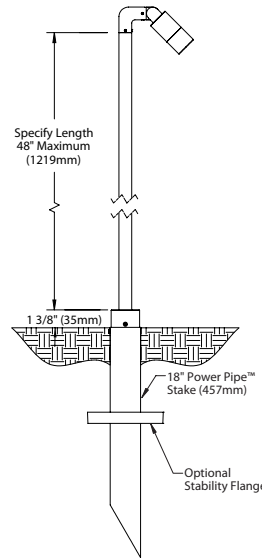
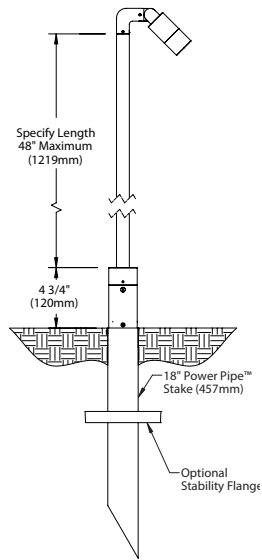
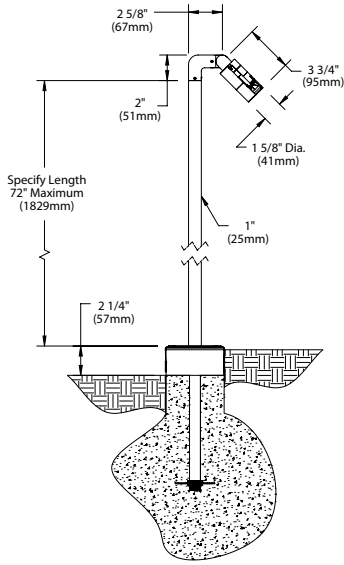
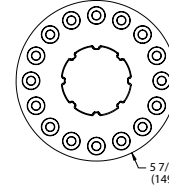

All dimensions indicated on this submittal are nominal. Contact Technical Sales if you require more stringent specifications.

SPECIFICATIONS

GreenSource Initiative™
Metal and packaging components are made from recycled materials. Manufactured using renewable solar energy, produced on site. Returnable to manufacturer at end of life to ensure cradle-to-cradle handling. Packaging contains no chlorofluorocarbons (CFC's). Use of this product may qualify for GreenSource efficacy and recycling rebate(s). Consult www.bklighting.com/greensource for program requirements.

Materials
Furnished in Copper-Free Aluminum (Type 6061-T6).

Style
'L' Style provides clean, 90° transition from fixture to stem.

Body
Fully machined from solid billet. Unibody design provides enclosed, water-proof wireway and integral heat sink for maximum component life. Integral knuckle for maximum mechanical strength. High temperature, silicone 'O' Ring provides water-tight seal.

Knuckle
The LOCK™ (Locking 'O' Ring Compression Knuckle) is comprised of two components. The first is integral to the body and features an interior, machined taper. The second is machined from solid billet and features a second, reverse angle taper. The resultant mechanical taper-lock allows a full 180° vertical adjustment without the use of serrated teeth, which inherently limit aiming. High temperature, silicone 'O' Ring provides water-tight seal and compressive resistance to maintain fixture position. Design withstands 73 lb. static load prior to movement to ensure decades of optical alignment. Biaxial source control with 360° horizontal rotation in addition to vertical adjustment.

Cap
Fully machined. Accommodates [1] lens or louver media. Choose from 45° cutoff ('A' or 'D'), 3/4" deep bezel with 90° cutoff ('B' or 'E'), or flush lens ('C') cap styles. Accommodates up to (2) lens or louver media. 'A' and 'B' caps include weep-hole for water and debris drainage. 'D' and 'E' caps exclude weep-hole and are for interior use only.

Stem
Fully machined, 1" dia. with internal threads for maximum visual appeal. Available in configurable lengths to 48" maximum overall.

Lens
Shock resistant, tempered, glass lens is factory adhered to fixture cap and provides hermetically sealed optical compartment. Specify soft focus (#12) or rectilinear (#13) lens.

BKSSL®
Integrated solid state system with 'e' technology is scalable for field upgrade. Modular design with electrical quick disconnects permit field maintenance. High power, forward throw source complies with ANSI C78.377 binning requirements. Exceeds ENERGY STAR® lumen maintenance requirements.

Integral, constant current driver. 12VAC/VDC input. 50/60Hz. Proprietary input control scheme achieves power factor correction and eliminates inrush current. Output, over-voltage, open-circuit, and short circuit protected. Inrush current limited to <250mA. Conforms to Safety Std. C22.2 No. 250.13-12.

Optics
Interchangeable OPTIKIT™ modules permit field changes to optical distribution. Color-coded for easy reference: Spot (SP) = Green. Narrow Flood (NFL) = Yellow. Flood (FL) = Blue.

Installation
Available for installation in three distinct mounting conditions:

Anchor Base (Standard)
Cast aluminum junction box with pass-through cover. 10" galvanized anchor stem for installation into soil or concrete. For use with 12VAC BKSSL remote transformer.

Power Pipe™ (Optional)
Provides a clean transition from wiring system to fixture. Schedule 80, 18" PVC housing for direct burial into soil or concrete. Machined 2-1/4" dia. cap for fixture mounting. Stainless steel hardware. Optional 6" diameter, molded stability flange, which simplifies installation and projects into substrate to reinforce housing stability. For use with 12VAC BKSSL remote transformer.

Power Pipe™ with Transformer Housing (Optional)
Additionally features integral transformer housing fully machined from copper-free aluminum. High temperature, silicone 'O' Ring provides water-tight seal. Integral, TRe20 electronic transformer. 105-300VAC primary voltage. 50/60Hz. Non Dimming. 20VA maximum load.

Remote Transformer
For use with 12VAC BKSSL remote transformer or magnetic transformers only. B-K Lighting cannot guarantee performance with third party manufacturers' transformers.

Wiring
PVC coated, 18AWG, 150V, 60°C rated and certified to UL 1838 standard.

Hardware
Tamper-resistant, stainless steel hardware. LOCK™ aiming screw and canopy mounting screws are additionally black oxide treated for additional corrosion resistance.

Finish
StarGuard®, our exclusive RoHS compliant, 15 stage chromate-free process cleans and conversion coats aluminum components prior to application of Class 'A' TGIC polyester powder coating.

Warranty
5 year limited warranty.

Certification and Listing
ITL tested to IESNA LM-79. Lighting Facts Registration per USD OE (www.lightingfacts.com). ETL Listed to ANSI/UL Standard 1838 and UL Subject 8750 and Certified to CAN/CSA Standard C22.2 No. 9. RoHS compliant. Suitable for indoor or outdoor use. Suitable for use in wet locations. IP 66 Rated. Made in USA.



*Energy Star is a registered trademark of the United States Environmental Protection Agency.