

Beam 4

Wall mount - Direct / Indirect

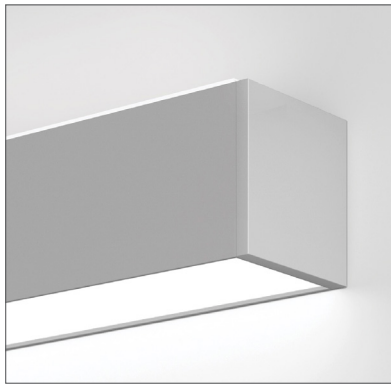

Flush Spotless Lens - down
Glo Lens - up

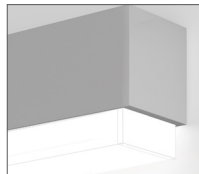

StepLens 1.5 - down

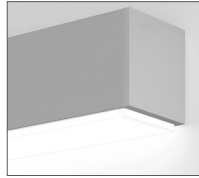

SurroundLite up
Glo lens - down

Project _____

Type _____

Notes _____

PERFORMANCE PER LINEAR FOOT AT 3500K

NOMINAL LUMEN OUTPUT		INPUT WATTS*	EFFICACY	SHIELDING I/D
UPLIGHT	DOWNLIGHT			
400 lm/ft	400 lm/ft	6.78 W/ft	118 lm/W	0.25G/0.25G
400 lm/ft	400 lm/ft	7.13 W/ft	112 lm/W	SO/0.25G
400 lm/ft	1000 lm/ft	12.04 W/ft	116 lm/ft	0.25G/0.25G
400 lm/ft	1000 lm/ft	12.4 W/ft	113 lm/ft	SO/0.25G
1100 lm/ft	400 lm/ft	12.5 W/ft	131 lm/W	0.25G/0.25G
1100 lm/ft	400 lm/ft	13.43 W/ft	112 lm/W	SO/0.25G
1100 lm/ft	1100 lm/ft	17.48 W/ft	119 lm/W	0.25G/0.25G
1100 lm/ft	1100 lm/ft	18.7 W/ft	112 lm/W	SO/0.25G

Please consult factory for custom lumen output and wattage.

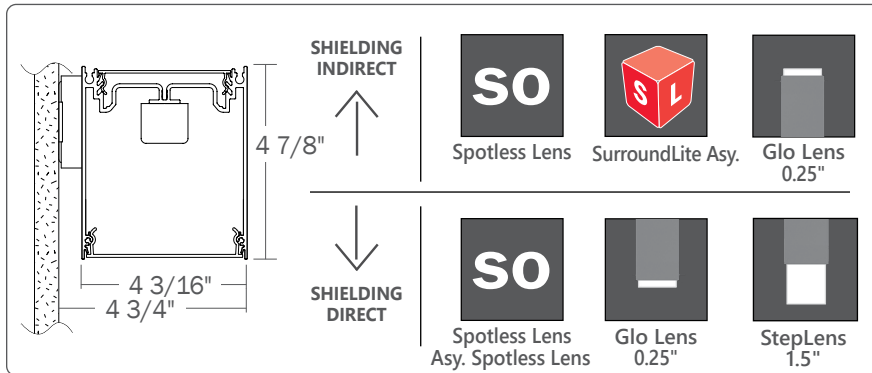

Ordering Guide

TB4WDILED		PRODUCT ID		NOM. LUM/FT UP		NOM. LUM/FT DOWN		CRI		COLOR TEMP.		SHIELDING INDIRECT		SHIELDING DIRECT	
TB4WDILED	BEAM 4 - Wall Direct/Indirect LED	400	400 lm/ft - Min. 1100 1100 lm/ft - Max.	400	400 lm/ft - Min. 1000 1000 lm/ft - Max.	80	80 CRI 90 90 CRI	27	2700 K 30 3000 K 35 3500 K 40 4000 K	SO	spotless lens SL surroundlite SLA surroundlite asymmetric 0.25G 0.25" Glo lens	SO	spotless lens ASO asy. with spotless lens 0.25G 0.25" Glo lens 1.5M StepLens, lum. end cap		
				Outputs between listed min and max are available. Consult factory for outputs outside of the listed range.								Choose only one of the options above			
												Choose only one of the options above; SurroundLite not available with direct			

LENGTH (FT)	MR (OPTIONAL)	FINISH	VOLTAGE	DRIVER	CIRCUITS
2 2' 3 3' 4 4' 5 5' 8 8' 12 12' S# System Run*	DMLD(#) downtlight module LED	AP aluminum paint W white BLK black C custom	120 120 V 277 277 V 347 347 V UNV universal	DP dimming (0-10V) 1% LT Lutron (1) BI bi-level dimming O other (2)	1 1 circuit 2 2 circuits +E(#) emergency circuit (3) +NL(#) night light circuit (3) +GTD(#) generator transfer device (3) +M MR
* SurroundLite available in 1' increments		Add 6" per lamp. Specify quantity Separate circuits included Requires 120V or 277V		(1) Specify system (2) Please consult factory; see page 2	
				(3) Specify quantity	

BATTERY (OPTIONAL)	OTHER (OPTIONAL)	IC CONTROLS (OPTIONAL)	CUSTOM (OPTIONAL)
B# battery pack (integral)	F fuse (4)	DS# daylight sensor OS# occupancy sensor DOS# daylight & occupancy sensor EN# Enlighted integral (5) ENR# Enlighted remote (5) WC# wireless control dimming	C custom
Minimum 5ft; Not available with 347V Please consult factory	(4) Requires 120V or 277V	(5) Please consult factory Specify quantity. Requires 8" blank. See integrated controls guide for more details.	Please specify

● CONSTRUCTION

Housing	Extruded aluminum (0.075" nominal) Up to 70% recycled content
End Cap	Cast aluminum
Interior Brackets	Die formed sheet steel (20 gauge)
Reflectors	White powder coated sheet steel (22 gauge)
Lenses	Extruded acrylic (0.070" nominal)
Mounting	Sheet metal bracket with fixture-mounted clip

● ELECTRICAL

Lutron driver*	LDE1 - EcoSystem H-Series (1%) LDE5 - EcoSystem 5-Series (5%) LTE - Hi-Lume® A-series 2Wires Forward Phase (1%) <small>*Consult factory</small>
Other drivers	DALI - Digital Addressable Lighting Interface DMX - Digital Multiplex LV - line voltage - Advance Mark 10 Xitanium SR - For wireless sensor POE (Power over Ethernet) - Low Voltage Lighting System.
Emergency	Integral emergency battery pack or emergency circuit optional.
Input Voltage	120V, 277V, 347V, UNV.

i Incorporating these components may have limitations or affect the length of the luminaire. Please contact factory for more details.

● LED SYSTEM

CRI	Minimum 80 or 90 color rendering index.
CCT	Choice of 2700K, 3000K, 3500K and 4000K color temperature with a great color consistency (within 3-step MacAdam ellipse). Both within fixture and fixture to fixture.
LED life	Minimum 50,000h with 85% of lumen maintenance in 25°C ambient temperature, in compliance with IES LM-80 testing measurements.
Thermal Management	Aluminum housing acting as the heat sink to maximize life.
Environment	Dry and damp rated in operating ambient temperatures of 0-40°C (32-104F).

● OPTICS

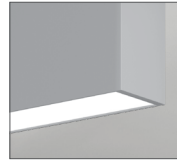

SO Spotless lens

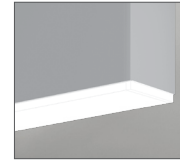

0.25G Glo lens

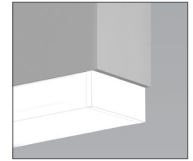

1.5M 1.5" StepLens

SPOTLESS LENS

Frosted acrylic snap-in micro lens

GLO LENS

0.25" frosted acrylic drop lens. Patented design.

STEPLENS

1.5" StepLens, illuminated end cap.

● SYSTEM (S#)

BEAM 4 linear systems, with the use of a strong profile, allow for a nearly hair thin connection system of continuous runs. Lengths of 4', 8', 12' as well as custom lengths are available. Runs of BEAM 4 that are greater than 12' in length are designated as systems (S#). This means that the run is comprised of a combination of 4', 8' and/or 12' sections to be assembled on site using our joining system. System runs with SurroundLite available in 1' increments only. For more information on systems and joining, please refer to the BEAM installation sheets available for download at www.axislighting.com.

● WARRANTY

Axis Lighting will warrant defective LEDs, boards, and drivers for 5 years from date of purchase. Warranty is valid if luminaire is installed and used according to specifications. If defective, Axis will send replacement boards or drivers at no cost along with detailed replacement instructions and instructions on how to return defective components to Axis.

● JOINERS

BEAM 4 luminaires feature the joining mechanism shown below. This mechanism joins and aligns multiple luminaires to create long continuous runs of light.

NOTE: Mount each system segment individually.
Do not assemble system prior to mounting.

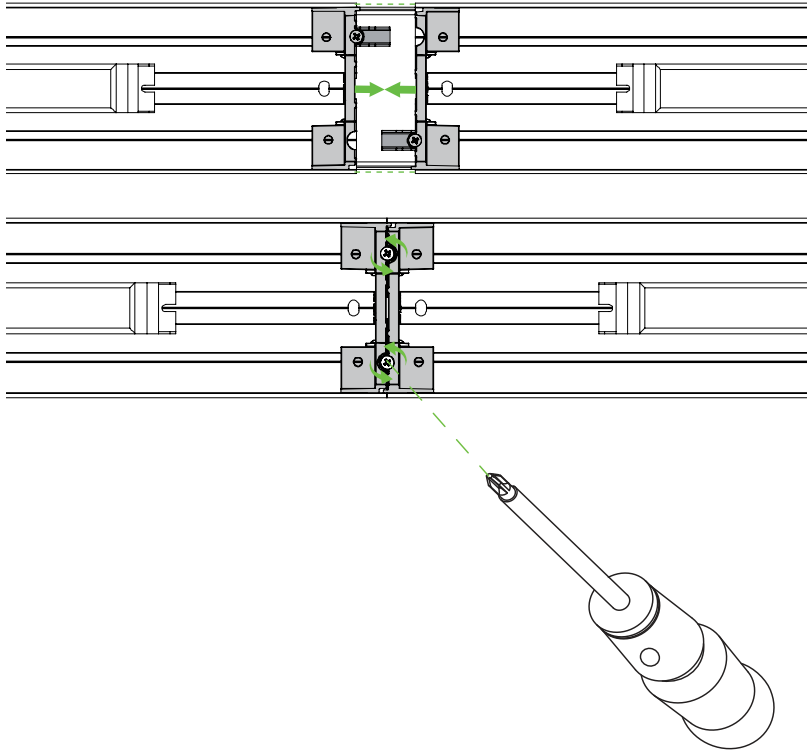

SECTION VIEWS

0.25G 0.25" Glo lens - Indirect

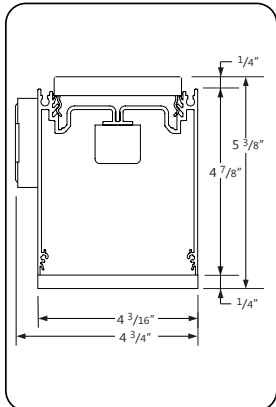

0.25G 0.25" Glo lens - Direct

SO Spotless Lens - Indirect

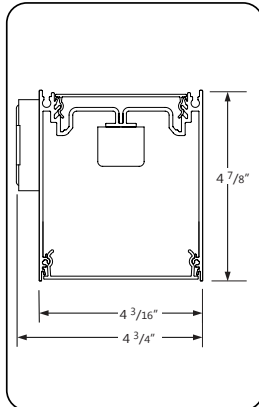

SO Spotless lens - Direct

SO Spotless Lens - Indirect

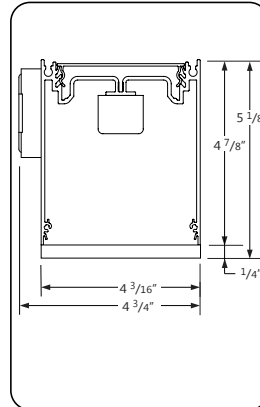

0.25G 0.25" Glo lens - Direct

0.25G 0.25" Glo lens - Indirect

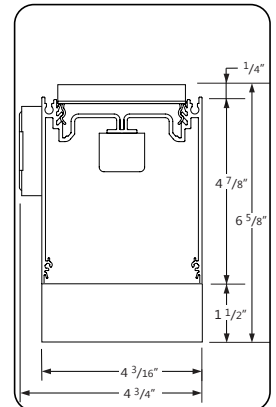

1.5M 1.5" StepLens - Direct

SO Spotless Lens - Indirect

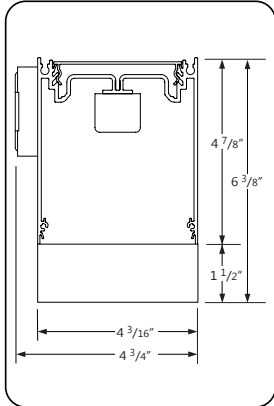

1.5M StepLens - Direct

0.25G 0.25" Glo lens - Indirect

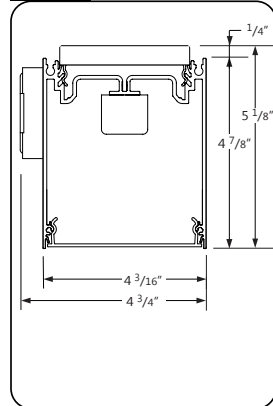

SO Spotless lens - Direct

SLA SurroundLite Asymmetric - Indirect

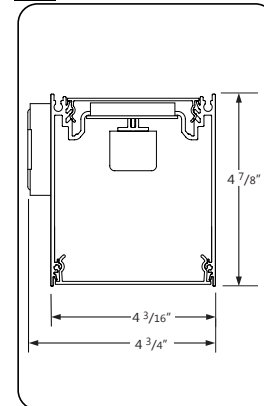

SO Spotless lens - Direct

SLA SurroundLite Asymmetric - Indirect

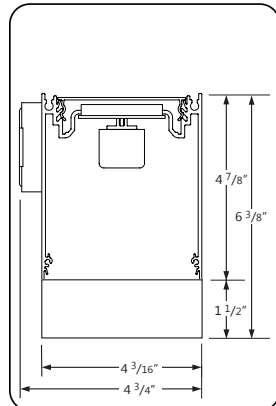

1.5M 1.5" StepLens - Direct

SLA SurroundLite Asymmetric - Indirect

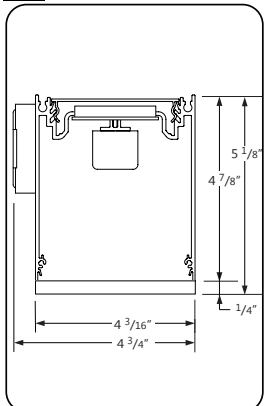

0.25G 0.25" Glo lens - Direct

0.25G 0.25" Glo lens - Indirect

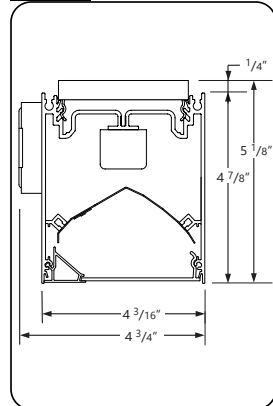

ASO Asymmetric with SO - Direct

SLA SurroundLite Asymmetric - Indirect

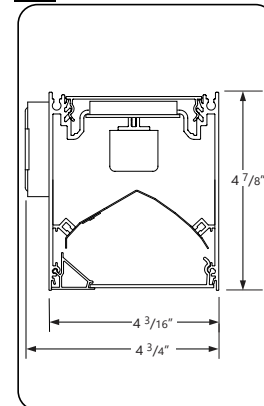

ASO Asymmetric with SO - Direct

SO Spotless lens - Indirect

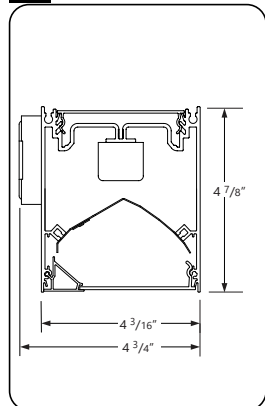

ASO Asymmetric with SO lens - Direct

● MOUNTING OPTIONS

HORIZONTAL MOUNTING DETAILS

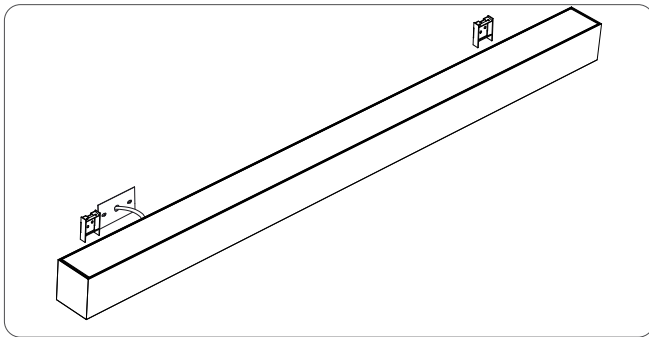

MOUNTING BRACKETS

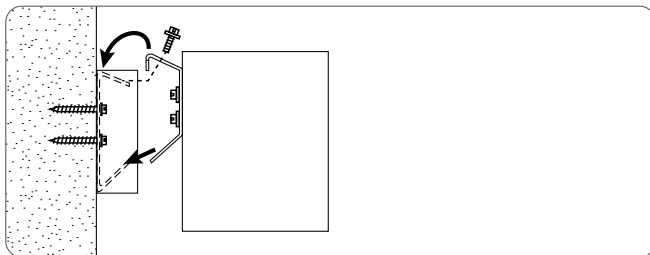

SIDE VIEW

● OTHER MOUNTING OPTIONS

BEAM 4 is also available with pendant mounted option.

i Specification sheets and installation sheets for all mountings for BEAM 4 luminaires are available for download at www.axislighting.com

● DOWNLIGHT MODLE LED

Blank DMLED Quantity

Extruded aluminum (0.075" nominal)
1.4" diameter
For every 4' section, there may be up to a maximum of 4 x DMLED lamps.
Each DMLED lamp is placed centered on a blank section 6" in length.

Spacing

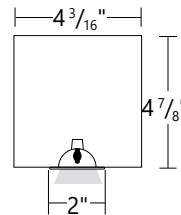

For a series of DM's within a given section length, they will be spaced evenly on a longer blank section.
The directed light of DMLED lamps are fixed downward.
Custom spacing may be available on special request.

Between sections

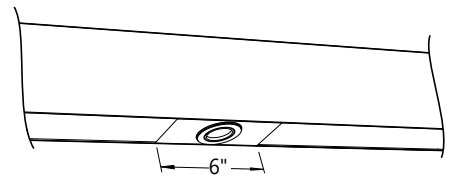

At luminaire ends

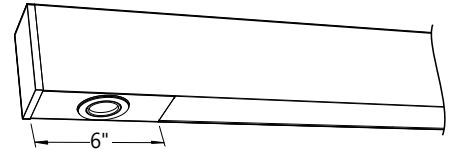

Several in a long blank section

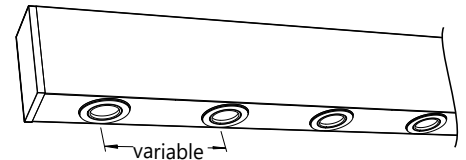

Beam Angle 45 nominal degrees
Input Watts 3W
Nominal Lumens 50 lumens
Efficacy 17 lumens per watt
Color Rendering Index (CRI) 80
Life 25,000 hours at L₇₀
Correlated color temperature (CCT) 2700K

i More options are available upon request.
Please consult factory.

● FINISH

Aluminium paint, powder coated and custom finishes are also available.

● APPROVALS

Certified to UL and CSA standards
Meets NYC requirements
Meets ADA requirements.
Suitable for damp locations.



Beam 4

Wall mount - Direct / Indirect

● PHOTOMETRIC DATA

0.25G 0.25 Glo Lens - Up
0.25G 0.25 Glo Lens - Down

Uplight
400 lm/ft
 Downlight
400 lm/ft



PHOTOMETRIC CURVE

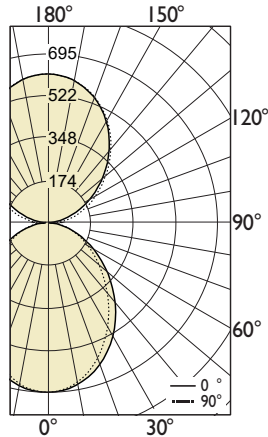

Lumen/ft up: 400.80 lm/ft
Lumen/ft down: 400.50 lm/ft
Total Lumens: 3205 lm (for 4ft)
Input Watts: 27.1 W
Efficacy: 118 lm/W

IES FILE: TB4DILED-400-400-80-35-0.25G-0.25G-4.IES

TESTED ACCORDING TO IES LM-79-2008

CANDELA DISTRIBUTION

Vertical Angle	Horizontal Angles				
	0	22.5	45	67.5	90
0	695	695	695	695	695
5	691	690	689	690	689
15	654	651	645	640	637
25	584	577	565	553	547
35	487	480	463	446	439
45	379	372	355	339	332
55	272	268	255	242	237
65	175	173	166	160	157
75	90	92	93	92	91
85	26	30	35	39	40
90	6	19	37	52	57
95	26	35	48	59	64
105	87	96	109	122	127
115	166	173	182	193	197
125	254	260	267	273	275
135	349	353	357	361	362
145	441	443	446	448	449
155	520	520	522	524	524
165	576	576	577	578	578
175	605	605	606	606	606
180	609	609	609	609	609

ZONAL LUMENS

Zone	Lumens
0	
0-10	65
10-20	182
20-30	260
30-40	289
40-50	274
50-60	228
60-70	165
70-80	98
80-90	41
90	
90-100	54
100-110	115
110-120	181
120-130	238
130-140	275
140-150	278
150-160	240
160-170	163
170-180	57
180	

LUMINANCE DATA (cd/m²)

Vertical Angle	Horizontal Angles		
	0	45	90
45	4717	4420	4127
55	4179	3907	3633
65	3632	3466	3261
75	3063	3151	3103
85	2611	3580	4007

SO Spotless Lens - Up
0.25G 0.25 Glo Lens - Down

Uplight
400 lm/ft
 Downlight
400 lm/ft



PHOTOMETRIC CURVE

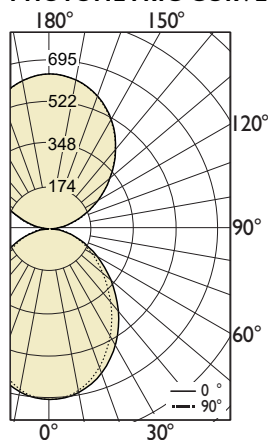

Lumen/ft up: 400.18 lm/ft
Lumen/ft down: 400.59 lm/ft
Total Lumens: 3203 lm (for 4ft)
Input Watts: 28.5 W
Efficacy: 112 lm/W

IES FILE: TB4DILED-400-400-80-35-SO-0.25G-4.IES

TESTED ACCORDING TO IES LM-79-2008

CANDELA DISTRIBUTION

Vertical Angle	Horizontal Angles				
	0	22.5	45	67.5	90
0	695	695	695	695	695
5	691	690	689	690	689
15	654	651	645	640	637
25	584	577	565	553	547
35	487	480	463	446	439
45	379	372	355	339	332
55	272	268	255	242	237
65	175	173	166	160	157
75	90	92	93	92	91
85	26	30	35	39	40
90	4	9	18	23	26
95	25	26	26	25	23
105	91	93	95	97	96
115	175	177	178	179	178
125	270	271	272	272	270
135	369	369	369	370	367
145	463	463	462	463	461
155	542	543	541	542	540
165	598	598	598	598	597
175	627	627	627	627	627
180	631	631	631	631	631

ZONAL LUMENS

Zone	Lumens
0	
0-10	65
10-20	182
20-30	260
30-40	289
40-50	274
50-60	228
60-70	165
70-80	98
80-90	39
90	
90-100	32
100-110	101
110-120	176
120-130	243
130-140	285
140-150	289
150-160	249
160-170	169
170-180	60
180	

LUMINANCE DATA (cd/m²)

Vertical Angle	Horizontal Angles		
	0	45	90
45	4717	4420	4127
55	4179	3907	3633
65	3632	3466	3261
75	3063	3151	3103
85	2611	3580	4007

i All IES files are available for download at: www.axislighting.com

Beam 4

Wall mount - Direct / Indirect

● PHOTOMETRIC DATA

0.25G 0.25 Glo Lens - Up
0.25G 0.25 Glo Lens - Down

Uplight
400 lm/ft
 Downlight
1000 lm/ft



PHOTOMETRIC CURVE

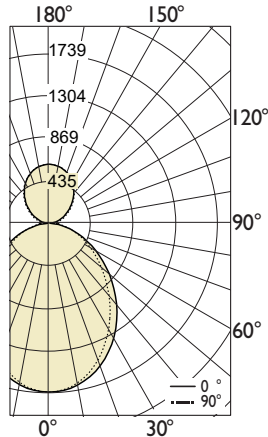

Lumen/ft up: 401.25 lm/ft
Lumen/ft down: 1000.75 lm/ft
Total Lumens: 5608 lm (for 4ft)
Input Watts: 48.15 W
Efficacy: 116 lm/W

IES FILE: TB4DILED-400-1000-80-35-0.25G-0.25G-4.IES

TESTED ACCORDING TO IES LM-79-2008

CANDELA DISTRIBUTION

Vertical Angle	Horizontal Angles				
	0	22.5	45	67.5	90
0	1739	1739	1739	1739	1739
5	1728	1725	1724	1724	1722
15	1636	1627	1613	1601	1594
25	1459	1444	1412	1383	1368
35	1219	1200	1157	1116	1097
45	948	931	888	848	829
55	681	669	637	606	592
65	436	432	416	400	392
75	225	231	232	230	228
85	65	76	89	97	99
90	11	31	58	79	86
95	26	35	48	59	64
105	87	96	109	122	127
115	166	173	182	193	197
125	254	260	267	273	275
135	349	353	357	361	362
145	441	443	446	448	449
155	520	520	522	524	524
165	576	576	577	578	578
175	605	605	606	606	606
180	609	609	609	609	609

ZONAL LUMENS

Zone	Lumens
0	
0-10	163
10-20	454
20-30	650
30-40	724
40-50	686
50-60	571
60-70	413
70-80	245
80-90	99
90	
90-100	56
100-110	115
110-120	181
120-130	238
130-140	275
140-150	278
150-160	240
160-170	163
170-180	57
180	

LUMINANCE DATA (cd/m²)

Vertical Angle	Horizontal Angles		
	0	45	90
45	11792	11049	10317
55	10448	9767	9082
65	9081	8664	8153
75	7657	7878	7757
85	6528	8951	10016

SO Spotless Lens - Up
0.25G 0.25 Glo Lens - Down

Uplight
400 lm/ft
 Downlight
1000 lm/ft



PHOTOMETRIC CURVE

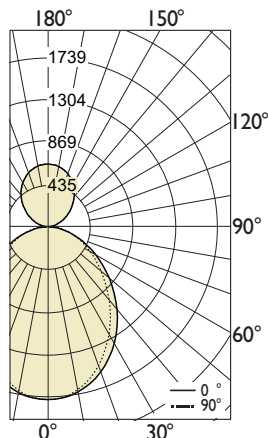

Lumen/ft up: 401.5 lm/ft
Lumen/ft down: 1000.20 lm/ft
Total Lumens: 5606 lm (for 4ft)
Input Watts: 49.6 W
Efficacy: 113 lm/W

IES FILE: TB4DILED-400-1000-80-35-SO-0.25G-4.IES

TESTED ACCORDING TO IES LM-79-2008

CANDELA DISTRIBUTION

Vertical Angle	Horizontal Angles				
	0	22.5	45	67.5	90
0	1739	1739	1739	1739	1739
5	1728	1725	1724	1724	1722
15	1636	1627	1613	1601	1594
25	1459	1444	1412	1383	1368
35	1219	1200	1157	1116	1097
45	948	931	888	848	829
55	681	669	637	606	592
65	436	432	416	400	392
75	225	231	232	230	228
85	65	76	89	97	99
90	9	21	37	48	51
95	25	26	26	25	23
105	91	93	95	97	96
115	175	177	178	179	178
125	270	271	272	272	270
135	369	369	369	370	367
145	463	463	462	463	461
155	542	543	541	542	540
165	598	598	598	598	597
175	627	627	627	627	627
180	631	631	631	631	631

ZONAL LUMENS

Zone	Lumens
0	
0-10	163
10-20	454
20-30	650
30-40	724
40-50	686
50-60	571
60-70	413
70-80	245
80-90	96
90	
90-100	34
100-110	101
110-120	176
120-130	243
130-140	285
140-150	289
150-160	249
160-170	169
170-180	60
180	

LUMINANCE DATA (cd/m²)

Vertical Angle	Horizontal Angles		
	0	45	90
45	11792	11049	10317
55	10448	9767	9082
65	9081	8664	8153
75	7657	7878	7757
85	6528	8951	10016

i All IES files are available for download at: www.axislighting.com

Beam 4

Wall mount - Direct / Indirect

● PHOTOMETRIC DATA

0.25G 0.25 Glo Lens - Up
0.25G 0.25 Glo Lens - Down

Uplight
1100 lm/ft
 Downlight
400 lm/ft



PHOTOMETRIC CURVE

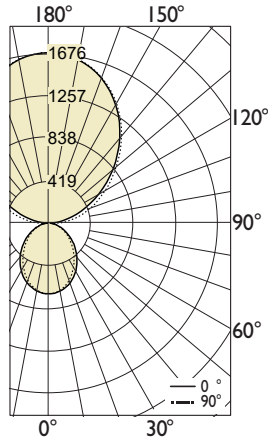

Lumen/ft up: 1100.5 lm/ft
Lumen/ft down: 402 lm/ft
Total Lumens: 6011 lm (for 4ft)
Input Watts: 30 W
Efficacy: 120 lm/W

IES FILE: TB4DILED-1100-400-80-35-0.25G-0.25G-4.IES

TESTED ACCORDING TO IES LM-79-2008

CANDELA DISTRIBUTION

Vertical Angle	Horizontal Angles				
	0	22.5	45	67.5	90
0	695	695	695	695	695
5	691	690	689	690	689
15	654	651	645	640	637
25	584	577	565	553	547
35	487	480	463	446	439
45	379	372	355	339	332
55	272	268	255	242	237
65	175	173	166	160	157
75	90	92	93	92	91
85	26	30	35	39	40
90	12	39	76	110	122
95	72	97	131	163	175
105	240	265	300	336	351
115	455	474	502	529	541
125	699	715	734	750	757
135	960	969	983	992	996
145	1213	1218	1227	1233	1234
155	1429	1430	1436	1440	1442
165	1584	1584	1586	1589	1590
175	1665	1665	1665	1666	1666
180	1676	1676	1676	1676	1676

ZONAL LUMENS

Zone	Lumens
0	
0-10	65
10-20	182
20-30	260
30-40	289
40-50	274
50-60	228
60-70	165
70-80	98
80-90	47
90	
90-100	144
100-110	317
110-120	497
120-130	655
130-140	757
140-150	766
150-160	661
160-170	447
170-180	158
180	

LUMINANCE DATA (cd/m²)

Vertical Angle	Horizontal Angles		
	0	45	90
45	4717	4420	4127
55	4179	3907	3633
65	3632	3466	3261
75	3063	3151	3103
85	2611	3580	4007

SO Spotless Lens - Up
0.25G 0.25 Glo Lens - Down

Uplight
1100 lm/ft
 Downlight
400 lm/ft



PHOTOMETRIC CURVE

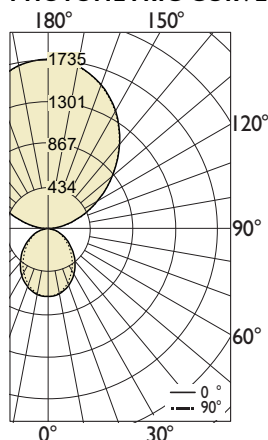

Lumen/ft up: 400.19 lm/ft
Lumen/ft down: 1100.27 lm/ft
Total Lumens: 6002 lm (for 4ft)
Input Watts: 53.7 W
Efficacy: 112 lm/W

IES FILE: TB4DILED-1100-400-80-35-SO-0.25G-4.IES

TESTED ACCORDING TO IES LM-79-2008

CANDELA DISTRIBUTION

Vertical Angle	Horizontal Angles				
	0	22.5	45	67.5	90
0	695	695	695	695	695
5	691	690	689	690	689
15	654	651	645	640	637
25	584	577	565	553	547
35	487	480	463	446	439
45	379	372	355	339	332
55	272	268	255	242	237
65	175	173	166	160	157
75	90	92	93	92	91
85	26	30	35	39	40
90	4	9	18	23	26
95	69	72	72	68	64
105	250	256	262	267	264
115	482	487	490	493	488
125	742	746	747	748	743
135	1014	1015	1014	1016	1009
145	1274	1274	1271	1272	1266
155	1491	1492	1488	1490	1485
165	1644	1645	1644	1645	1642
175	1724	1725	1724	1725	1724
180	1735	1735	1735	1735	1735

ZONAL LUMENS

Zone	Lumens
0	
0-10	65
10-20	182
20-30	260
30-40	289
40-50	274
50-60	228
60-70	165
70-80	98
80-90	39
90	
90-100	82
100-110	277
110-120	485
120-130	667
130-140	782
140-150	795
150-160	685
160-170	463
170-180	164
180	

LUMINANCE DATA (cd/m²)

Vertical Angle	Horizontal Angles		
	0	45	90
45	4717	4420	4127
55	4179	3907	3633
65	3632	3466	3261
75	3063	3151	3103
85	2611	3580	4007

i All IES files are available for download at: www.axislighting.com

Beam 4

Wall mount - Direct / Indirect

● PHOTOMETRIC DATA

0.25G 0.25 Glo Lens - Up
0.25G 0.25 Glo Lens - Down

Uplight
1100 lm/ft
 Downlight
1000 lm/ft



PHOTOMETRIC CURVE

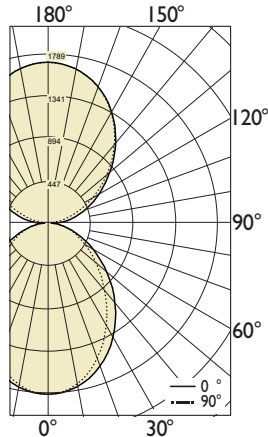

Lumen/ft up: 1002.18 lm/ft
Lumen/ft down: 1101.25 lm/ft
Total Lumens: 8414 lm (for 4ft)
Input Watts: 71 W
Efficacy: 119 lm/W

IES FILE: TB4DILED-1100-1000-80-35-0.25G-0.25G-4.IES

TESTED ACCORDING TO IES LM-79-2008

CANDELA DISTRIBUTION

Vertical Angle	Horizontal Angles				
	0	22.5	45	67.5	90
0	1739	1739	1739	1739	1739
5	1728	1725	1724	1724	1722
15	1636	1627	1613	1601	1594
25	1459	1444	1412	1383	1368
35	1219	1200	1157	1116	1097
45	948	931	888	848	829
55	681	669	637	606	592
65	436	432	416	400	392
75	225	231	232	230	228
85	65	76	89	97	99
90	16	50	97	137	151
95	72	97	131	163	175
105	240	265	300	336	351
115	455	474	502	529	541
125	699	715	734	750	757
135	960	969	983	992	996
145	1213	1218	1227	1233	1234
155	1429	1430	1436	1440	1442
165	1584	1584	1586	1589	1590
175	1665	1665	1665	1666	1666
180	1676	1676	1676	1676	1676

ZONAL LUMENS

Zone	Lumens
0	
0-10	163
10-20	454
20-30	650
30-40	724
40-50	686
50-60	571
60-70	413
70-80	245
80-90	104
90	
90-100	147
100-110	317
110-120	497
120-130	655
130-140	757
140-150	766
150-160	661
160-170	447
170-180	158
180	

LUMINANCE DATA (cd/m²)

Vertical Angle	Horizontal Angles		
	0	45	90
45	11792	11049	10317
55	10448	9767	9082
65	9081	8664	8153
75	7657	7878	7757
85	6528	8951	10016

SO Spotless Lens - Up
0.25G 0.25 Glo Lens - Down

Uplight
1100 lm/ft
 Downlight
1000 lm/ft



PHOTOMETRIC CURVE

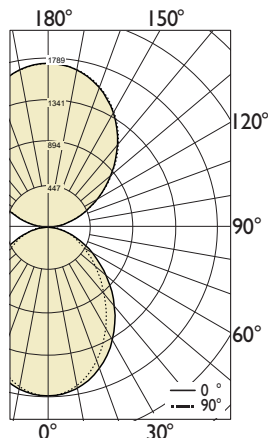

Lumen/ft up: 1000.31 lm/ft
Lumen/ft down: 1100.97 lm/ft
Total Lumens: 8405 lm (for 4ft)
Input Watts: 74.8 W
Efficacy: 112 lm/W

IES FILE: TB4DILED-1100-1000-80-35-SO-0.25G-4.IES

TESTED ACCORDING TO IES LM-79-2008

CANDELA DISTRIBUTION

Vertical Angle	Horizontal Angles				
	0	22.5	45	67.5	90
0	1739	1739	1739	1739	1739
5	1728	1725	1724	1724	1722
15	1636	1627	1613	1601	1594
25	1459	1444	1412	1383	1368
35	1219	1200	1157	1116	1097
45	948	931	888	848	829
55	681	669	637	606	592
65	436	432	416	400	392
75	225	231	232	230	228
85	65	76	89	97	99
90	11	24	41	52	53
95	69	72	72	68	64
105	250	256	262	267	264
115	482	487	490	493	488
125	742	746	747	748	743
135	1014	1015	1014	1016	1009
145	1274	1274	1271	1272	1266
155	1491	1492	1488	1490	1485
165	1644	1645	1644	1645	1642
175	1724	1725	1724	1725	1724
180	1735	1735	1735	1735	1735

ZONAL LUMENS

Zone	Lumens
0	
0-10	163
10-20	454
20-30	650
30-40	724
40-50	686
50-60	571
60-70	413
70-80	245
80-90	97
90	
90-100	85
100-110	277
110-120	485
120-130	667
130-140	782
140-150	795
150-160	685
160-170	463
170-180	164
180	

LUMINANCE DATA (cd/m²)

Vertical Angle	Horizontal Angles		
	0	45	90
45	11792	11049	10317
55	10448	9767	9082
65	9081	8664	8153
75	7657	7878	7757
85	6528	8951	10016

i All IES files are available for download at: www.axislighting.com

● PHOTOMETRIC DATA - ASYMMETRIC DIRECT

ASO Asy. Spotless Lens - Down

Downlight
500 lm/ft



PHOTOMETRIC CURVE

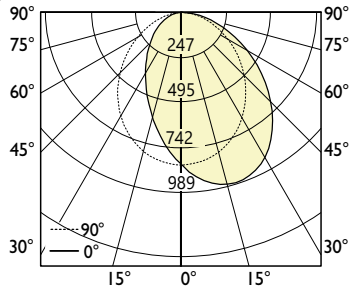

Lumen/ft down: 524 lm/ft
Total Lumens: 2096 lm/4ft)
Input Watts: 22.03 W
Efficacy: 95 lm/W

IES FILE: TB4LED-500-80-30-ASO-4 .IES

TESTED ACCORDING TO IES LM-79-2008

CANDELA DISTRIBUTION

Vertical Angle	Horizontal Angles				
	0	22.5	45	67.5	90
0	846	846	846	846	846
5	915	911	897	867	839
15	986	972	932	872	798
25	965	949	901	821	719
35	860	846	801	719	611
45	694	686	653	581	484
55	508	502	479	428	353
65	324	321	308	277	228
75	164	164	159	144	120
85	36	37	39	38	34
90	1	1	1	1	1

ZONAL LUMENS

Zone	Lumens
0	
0-10	80
10-20	225
20-30	331
30-40	381
40-50	372
50-60	315
60-70	227
70-80	128
80-90	37
90	0

LUMINANCE DATA (cd/m²)

Vertical Angle	Horizontal Angles		
	0	45	90
45	10871	10226	7583
55	9798	9254	6821
65	8480	8078	5982
75	7030	6809	5125
85	4622	4976	4276

i All IES files are available for download at: www.axislighting.com