

FIXTURE SPECIFICATIONS

INTENDED USE

The **Continuum Architectural LED Recessed Trimless Fixture** features a customizable design and color changing capabilities. The Continuum is an ideal option for interiors seeking a uniquely modern aesthetic.

PRODUCT FAMILY

- 12100-23** | Continuum 23
- 12100-44** | Continuum 44
- 12100-66** | Continuum 66

FEATURES

- Construction:** Durable, Military Grade Aluminum
- Field Cuttable
- Installs Within Drywall Depth
- Can Be Installed in Any Drywall Thickness
- Home Run Required at Every 16'
- LED Driver:** Remote Transformer is Provided
- Beam Angle:** 120°
- Lens:** Glare-Free, Frosted
- Finish:** Matte White
- Voltage:** 24V DC Constant Voltage
- Wattage:** 6W/FT
- Lumens:** *Standard:* 500 lms/FT
- Color Changing:* 380 lms (White) | 185 lms (RGB)
- Life:** 50,000 Hours
- Warranty:** 5 Years
- Listings:** cUL Listed
- Title 24 JA8 Certified
- Wet Location on LED Component Only



ORDERING INFORMATION Example: (12100-10-RGBW-2-27K-010-IP65)

Model	Size	Color Temp	Driver	Options
12100-10-RGBW	2 2 FT	<i>Standard</i>	MLV Magnetic Low Voltage	IP65 Wet Location Rated
	4 4 FT	27K 2700K	LUT1 Lutron 1% Dimming	
	6 6 FT	30K 3000K	010 0-10V Dimming	
	8 8 FT	40K 4000K	TRIAC TRIAC Electronic	
		50K 5000K	RGBCV² Hardwire Constant Voltage	
		<i>Color Changing¹</i>		
		RGB27K 2700K		
		RGB30K 3000K		
		RGB40K 4000K		
		RGB50K 5000K		

RGB-W WALL CONTROLLER²

Model	Finish
RGB-WC	BK Black
	WH White

RGB-W DMX Decoder^{2,3}

Decoder	No. of Zones
RGB-DEC	_/10
DMX512 Decoder	Zones

¹RGB DMX Wall Controller & Decoder Required (See p.3)

²Only Required for RGB Color Changing Models

³One Decoder Required per Zone

STANDARD DIMMABLE POWER SUPPLIES

MAGNETIC LOW VOLTAGE (MLV)



Class 2

TRDM-20W-24V	5.6" x 2" x 2.14"
TRDM-40W-24V	5.6" x 2" x 2.14"
TRDM-60W-24V	6.5" x 2.2" x 2.5"
TRDM-100W-24V	6.5" x 2.2" x 2.5"
TRDM-192W-24V	7" x 7" x 3.2"
TRDM-288W-24V	7" x 7" x 3.2"

Non-Class 2

TRDM-150W-24V	9.8" x 3" x 3"
TRDM-200W-24V	9.8" x 3" x 3"
TRDM-300W-24V	9.8" x 4.2" x 3.5"

*Available in 120V or 277V

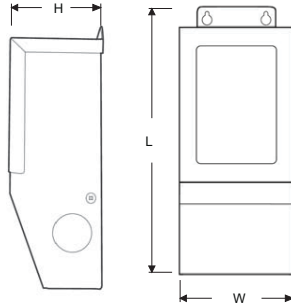

HIGH PERFORMANCE MLV



Class 2

TRDH-48W-24V	11.25" x 3.37" x 3.25"
TRDH-96W-24V	11.25" x 3.37" x 3.25"
TRDH-288W-24V	14.25" x 8.43" x 4.43"

*Available in 120V or 277V

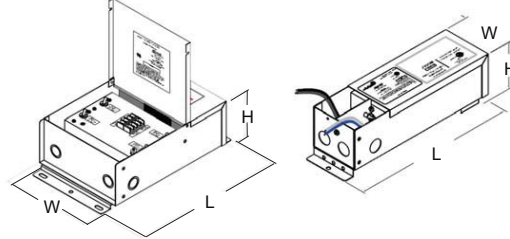

LUTRON 1% DIMMING



Class 2

2-Wire	LTEA4U1UKL-CV240	4.0" x 1.5" x 4.0"
3-Wire	L3DA4U1UKL-CV240	4.0" x 1.5" x 4.0"

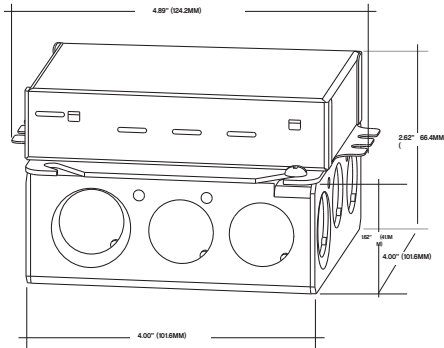

LUTRON .1% DIMMING



Class 2

TRDE-96W-24V-ECO	10.5" x 3" x 2"
------------------	-----------------

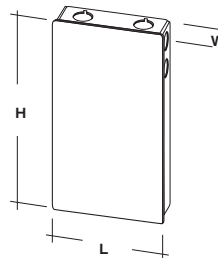

0-10V DIMMING (with JUNCTION BOX)



Class 2

TRDE-100W-24V-010-JB	12.32" x 1.77" x 1.67"
----------------------	------------------------

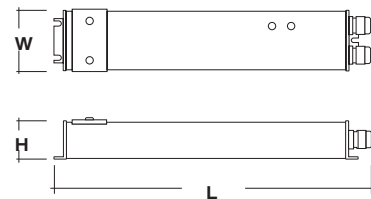

TRIAC DIMMING ELECTRONIC



Class 2

TRDT-20W-24V	6.1" x 2.12" x .79"
TRDT-40W-24V	7.0" x 2.4" x .95"
TRDT-60W-24V	7.1" x 2.36" x 1.38"
TRDT-96W-24V-JB	9.06" x 2.76" x 1.82"

Non-Class 2

TRDT-150W-24V-JB	8.92" x 3" x 1.85"
TRDT-200W-24V-JB	8.92" x 3" x 1.85"

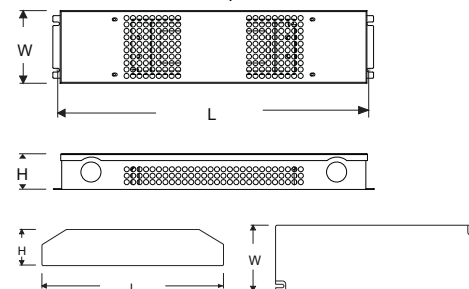

COLOR CHANGING NON-DIMMABLE POWER SUPPLIES

HARDWIRE CONSTANT VOLTAGE

Class 2

TRHW-10W-24V	2.55" x 1.37" x .90"
TRHW-20W-24V	4.64" x 1.38" x 1.2"
TRHW-35W-24V	5.83" x 1.57" x 1.18"
TRHW-60W-24V	6.38" x 1.65" x 1.18"

Non-Class 2

TRHW-100W-24V	7.44" x 2.4" x 1.45"
TRHW-150W-24V	8.75" x 2.68" x 1.53"
TRHW-200W-24V	9.62" x 2.68" x 1.53"
TRHW-300W-24V	9.92" x 3.55" x 1.75"

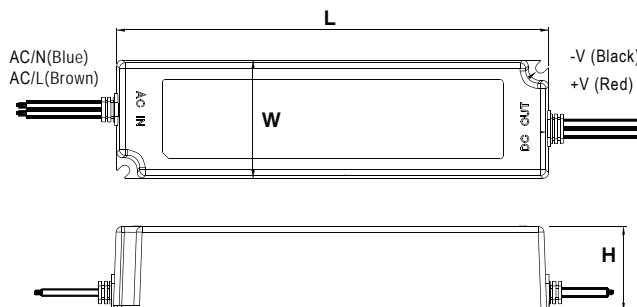



CONTROLLER SPECIFICATIONS

INTENDED USE

Control lighting, color temperature, and dimming remotely with a single wall unit through network communication

FEATURES

Channels: 1024 DMX
Control: Up to 340 RGB Fixtures
Zones: Multi-room Control with 10 Zones, 500 Scenes

SPECIFICATIONS

Construction: Touch Sensitive Buttons and Color Wheel for Accurate Color Selection
Output Protocol: DMX512 (X2)
Connections: USB / Ethernet / RS232 Clock / 8 Dry Contact Ports
 5V Output Relay
Mounting: Single or Double Gang Socket
Memory: microSD
Power: 6V DC / 0.6A
Temperature: 14°F - 113°F
Compatibility: MAC / PC / Android / iOS
Software: Nicolaudie (Included)
Standards: EC / EMC / ROHS / ETL

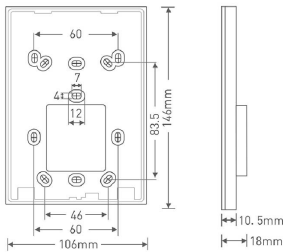

DECODER SPECIFICATIONS

DESCRIPTION

Constant Voltage DMX512 Decoder with Digital Display
 One Decoder is required per zone.

SPECIFICATIONS

Input Voltage: 12-36V DC
Input Signal: DMX512
Output Voltage: 12-36V DC
Output PWM Channels: 3 or 4 Selectable
Output Amps: 5A per Channel
Output Wattage: 60W (12V) | 120W (24V)
Operating Temperature: -4°F - 122°F
Data Ports: RJ45
Compatibility: RGB & RGB+W Systems
 12V DC and 24V DC Systems

INSTALLATION

Make sure the controller has the proper voltage and wattage for the intended job.
 Check wiring to make sure they match the diagram.

Select a suitable and proper location to mount the DMX decoder.
 Consider distance of transformer and LED fixture from controller to determine appropriate wire.

RGB DMX512 DECODER

